

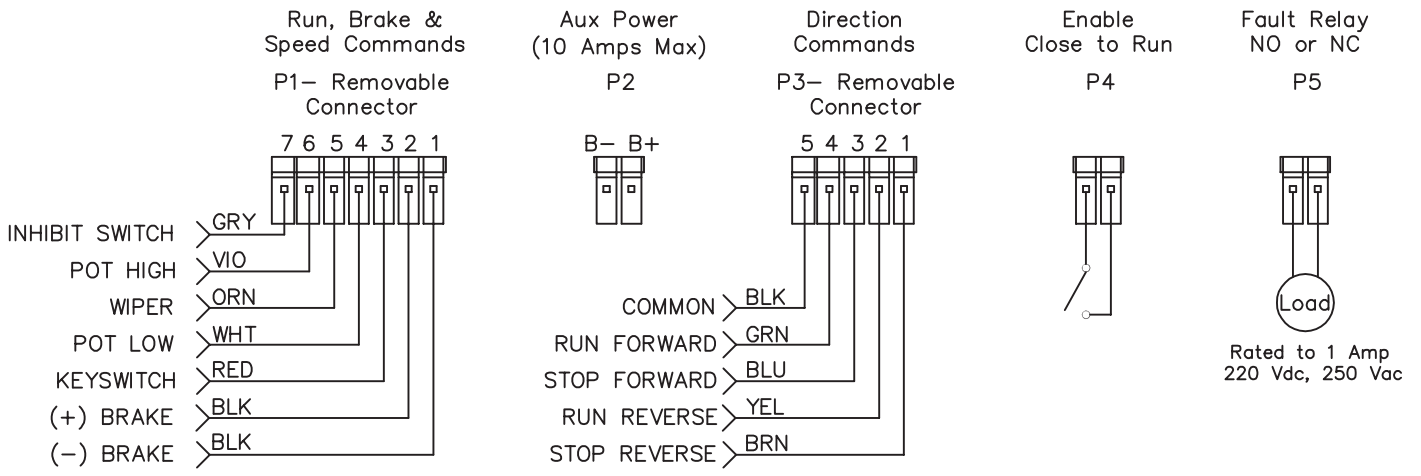

"The Right Control
 for your Application"

KBBC-MICRO CONNECTION DIAGRAM

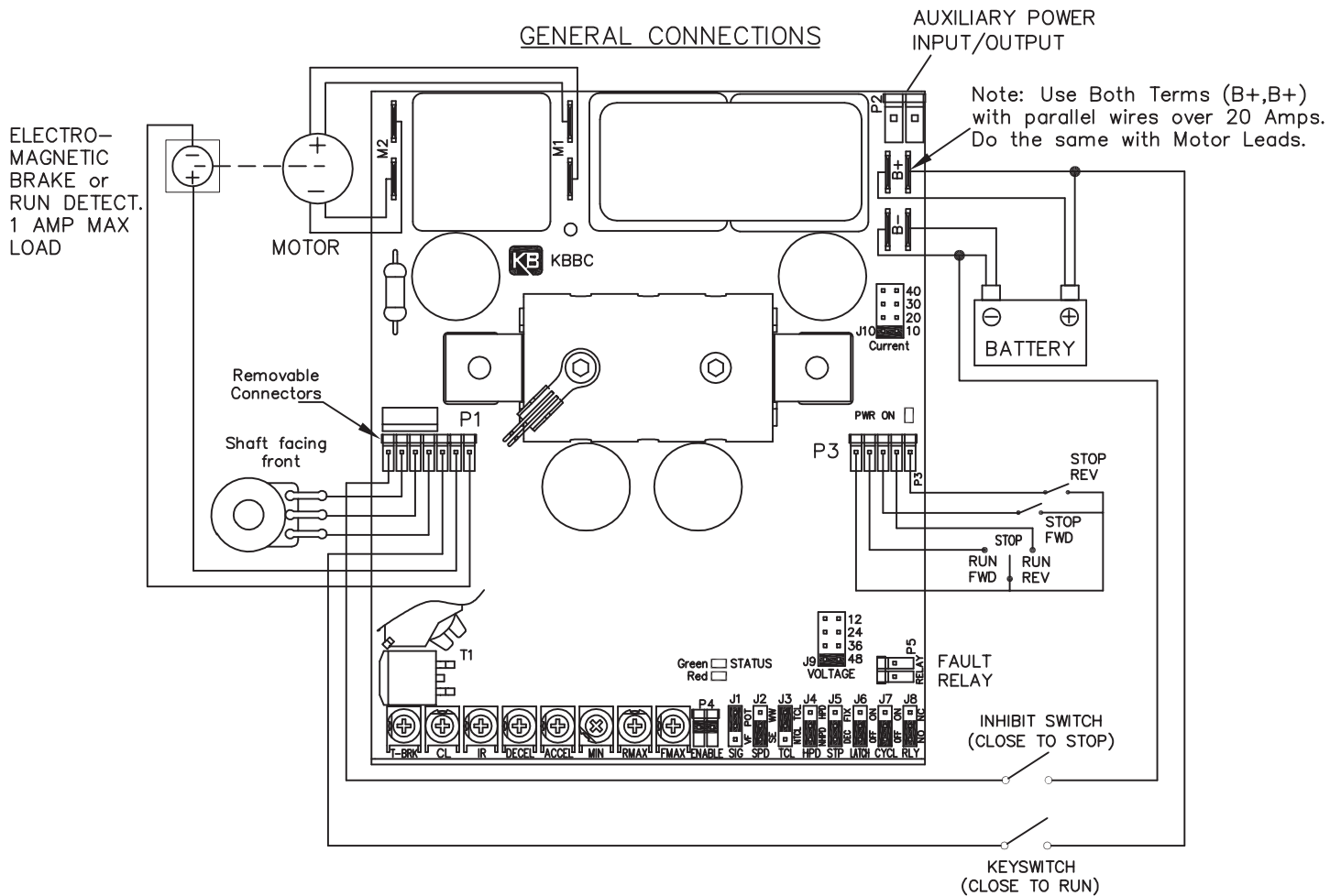

KBBC-MICRO FUNCTIONAL DESCRIPTIONS

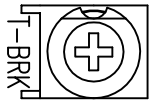

TIMED BRAKE DELAY (T-BRK)- This adjusts time delay before the brake engages after the drive is told to stop. Brake is initiated by Enable, or Keyswitch opening, or inhibit terminals closing.

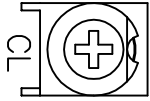

CURRENT LIMIT (CL)- Allows adjustability of current limit setpoint. Typically set at 1.5 X the Motor FLA. When Current Limit engages the status light will indicate by turning red.

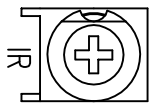

IR COMPENSATION (IR)- Allows adjustment of load compensation for different motors. Smaller motors require more compensation to overcome losses in armature winding. Typically set by checking No Load to Full Load speed changes.

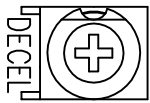

DECELERATION (DECEL)- Allows for controlled deceleration from full speed to zero speed, from 0.1 to 15 seconds as pot is turned clockwise. Decel works with all stop modes except inhibit. When inhibit is used the decel pot has no effect, output will go to zero in 0.1 seconds.

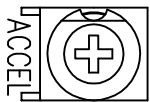

ACCELERATION (ACCEL)- Allows for controlled acceleration from zero to full speed. From 0.1 to 15 seconds as pot is turned clockwise. Accel is active in any turn on condition, including Enable, Keyswitch, or release of inhibit.

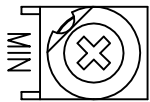

MINIMUM SPEED (MIN)- Sets the minimum speed the motor will run. Factory set to zero speed, but can be adjusted from 0-30% of full speed.

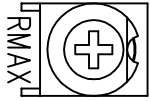

MAXIMUM REVERSE SPEED (RMAX)- Limits the maximum allowable speed in the reverse direction. Range is 50-100% of Forward speed (RMAX is dependant on FMAX setting).

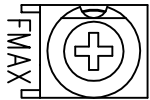

MAXIMUM FORWARD SPEED (FMAX)- Limits the maximum allowable speed in the forward direction. Range is 60-100 % of full speed. Set for Full Travel 5K Pot. For limited travel of Pot (ex. 1/4 rotation=desired full range), FMAX can be turned clockwise to compensate.

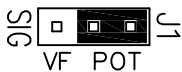

SIGNAL JUMPER (J1)- Voltage Following/ Potentiometer. Selects either potentiometer speed control, or remote 0-5 Vdc signal input. (See page 4).



SPEED MODE JUMPER (J2)- Wig Wag/ Single Ended. Allows for choice of Wig Wag speed control, (center of pot is zero speed, clockwise is forward, counter is reverse), or Single Ended, (contact closure chooses direction). (See page 4).

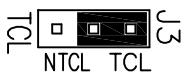

TIMED CURRENT LIMIT JUMPER (J3)- Non Timed Current Limit/ Timed Current Limit. Disables or enables the shutdown of the drive due to motor overcurrent after 7 seconds.



HIGH PEDAL DISABLE JUMPER (J4)- Non High Pedal Disable/ High Pedal Disable. In HPD the main speed pot needs to be reset to zero before motor is allowed to run.



STOP MODE JUMPER (J5)- Decel/ Fixed. Allows stop function (Enable, Keyswitch, Direction Command) to use deceleration trimpot for controlled stop, or fixed stop of 0.1 second.



LATCH JUMPER (J6)- Off/ On. Allows choice of how direction commands are activated. If latch is in "OFF" position, direction commands need to be maintained to run. If Latch is in the "ON" position, direction commands are momentary to run or stop. (See page 4).

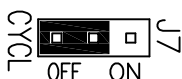

CYCLE (J7)- Off/ On. When the drive is commanded to stop, an output relay closes to short motor leads together. This action will act like a dynamic brake and impede motor travel. If this action is not desired, the cycle jumper can be placed in the "ON" position. (see page 4).

KBBC-MICRO FUNCTIONAL DESCRIPTIONS



RELAY (J8)- NO/ NC. Used to give option of fault relay output condition.

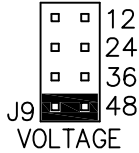

VOLTAGE SELECTION JUMPER (J9)- This Jumper calibrates the Drive to input and output for 12, 24, 36, or 48 Vdc inputs. This Jumper primarily sets up the Overvoltage and Undervoltage set points.

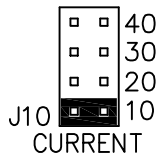

CURRENT SELECTION JUMPER (J10)- This Jumper calibrates the Drive for motors rated 10, 20, 30 or 40 amps. The Current Limit will be set up based on this setting X 1.5. The CL Trimpot can be used to modify this setting.

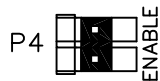

ENABLE (P4)- This connection is an additional method for Run/Stop. Close to Run, Open to stop.

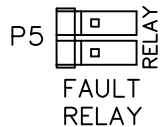

FAULT RELAY CONNECTOR (P5)- Provides a dry contact to indicate fault condition has occurred. This output is used in conjunction with Jumper J8 for NO or NC operation. The fault relay will change state when the Keyswitch is applied. The relay will trip on any fault condition: Speed Pot Fault (open lead), Over Temperature Fault, Over/Under Voltage, Motor Brake Fault, Internal Fault (micro failure), and Timed Current Limit. Reset by cycling Keyswitch.



POWER ON LED- This green LED is illuminated when the Keyswitch is engaged.

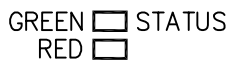

STATUS LEDs- These two LED's are used to indicate drive status. The top LED is green, the one directly below it is red. The Drive condition will be determined by the table shown below:

LED Ref.	Function	Flash Code	LED Color
	Normal Control Operation	Slow	Green
	Stop Mode	Quick	Green
	Speed Pot Fault	Quick	Red/Green (Alternate)
	Temperature Fault	Slow	Red/Green (Alternate)
STATUS	Over/Under voltage	Quick	Red+Green
Green, Red	Undervoltage Warning	Slow	Red+Green
	Motor/Brake Fault	Quick	Red, Red / Green, Green
	Internal Fault)	Slow	Red, Red / Green, Green
	Current Limit	Steady	Red
	TCL (Current Limit Time Out)	Quick	Red
"PWR" (Power)	Normal Control Operation	Steady	Green
Green	Bus & Power Supply Fault	Off	

Slow flash: 1 Sec. on, 1 Sec. off

Quick flash: 0.15 Sec. on, 0.15 Sec off

KBBC-MICRO FUNCTIONAL DESCRIPTIONS DIRECTION AND SPEED COMMAND SETTINGS

MODE SETTINGS	DIRECTIONAL SETTINGS		
	WIG-WAG MOMENTARY SWITCHING	SINGLE-ENDED MOMENTARY SWITCHING	MAINTAINED SWITCHING
CONNECTOR P3	<p style="text-align: center;">TO RESET, POT MUST BE RETURNED TO NEUTRAL POSITION (CENTER OFF)</p>		<p style="text-align: center;">LIMIT SWITCHES OVERRIDE FWD-STOP-REV SWITCH</p>
JUMPERS			

MODE SETTINGS	SPEED INPUT SETTINGS	
	VOLTAGE FOLLOWING	POTENTIOMETER CONTROL
CONNECTOR P1	<p style="text-align: center;">SEE TABLE 1 FOR SPEED INPUT VALUES</p>	<p style="text-align: center;">50K OHM MAX SPEED LIMIT CAN BE USED OR USE MAX. MAX TRIMPOTS</p>
JUMPERS		

Notes:

- 1) Inhibit Function is used for immediate (0.1 sec) deceleration. Close to stop.
- 2) Keyswitch Function is used to enable power to the drive. "Power On" light will illuminate to indicate the keyswitch is activated.
- 3) Main speed potentiometer (included) is rated 5 Kohm, 1/3 watt, wirewound.
- 4) Wig-Wag applications typically use a spring return to center potentiometer (not supplied or available through KB Electronics).
- 5) Cycle Jumper (J7) - The mechanical life of a relay is 10 million cycles. The Cycle Jumper is useful for repetitive cycling ON/OFF. When in "OFF" position the relay will engage to brake. When in "ON" position it will not. This will limit the use of the relay.
- 6) Keyswitch Function is used to enable power to the drive. "Power On" light will illuminate to indicate the keyswitch is activated.

TABLE 1, SPEED INPUTS.

DIRECTION	INPUT SIGNAL (VDC)	
	WIGWAG	SINGLE END
MAXIMUM FORWARD	4.7 + 0.3	4.7 + 0.3 (RUN FWD SELECTED)
NEUTRAL	2.5 ± 0.3	0 + 0.3
MAXIMUM REVERSE	0 + 0.3	4.7 + 0.3 (RUN REV SELECTED)

- 7) Momentary Limit Switch bypass protection. If limit switch is engaged in either direction (Stop Fwd, Stop Rev), the same direction run command will not allow continued travel. Ex. Run Fwd, Stop Fwd, will not allow Run Fwd Command until Run Reverse is called. If indexing is required, (Momentary Run Fwd, Momentary Stop Fwd, then Momentary Run Fwd in same direction), the stop reverse (P3-1) must be connected to COM (P3-5), otherwise unit will not go forward the second time.