

SafeLine Enclosed Disconnect switches



SafeLine

Compact, heavy duty

Enclosed disconnect switches

16A – 3150A Non-fusible

30A – 3000A Fusible

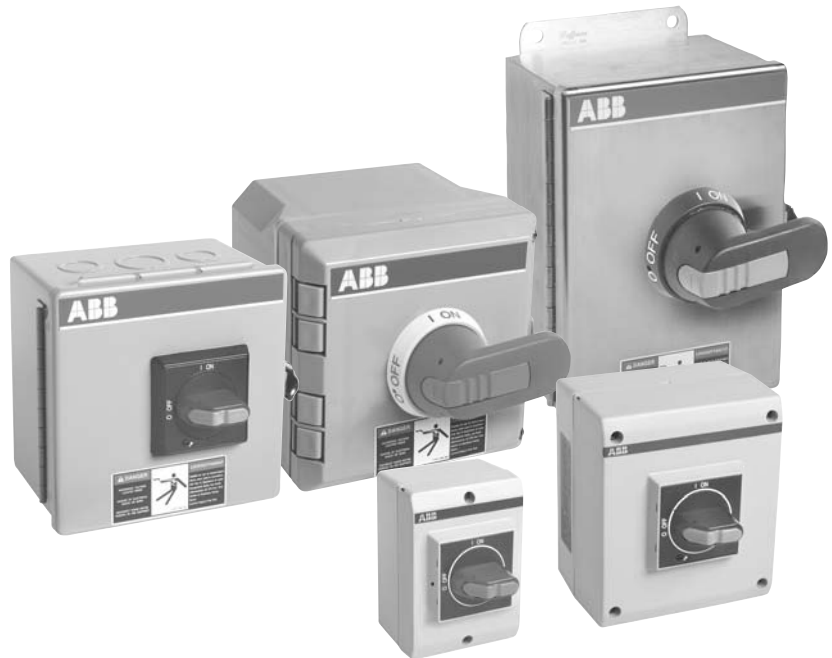

SafeLine enclosed disconnect switches are designed to meet customer requirements in terms of safety, ease of installation, space savings and operational convenience. They are available in a wide range of amperage ratings, are UL approved and NEMA rated to satisfy rugged industrial environments.

- Suitable for use as:**
- OSHA Lockout/Tagout disconnects
 - Safety switches
 - Load break switches
 - Isolators

General information

Non-fusible

NF 16 E - 3P BJ A 11

Disconnect switch type

NF = Non-fusible
 FC = UL Fused Class CC, (30A)
 FJ = UL Fused Class J, (30A – 600A)
 FL = UL Fused Class L, (800A)
 FT = UL Fused Class T, (100A – 800A)
 F* = Fused Class *special customer requirements

Disconnect switch frame size

Non-Fusible switches

16	25	30	32	45	60
63	100	125	200	400	600
800	1200	1600	2000	3150	

Fusible switches

30	60	100	200	400	600
800	1200 - 3000 – consult factory				

Environmental rating

1 = Type 1
 2 = Type 12
 3 = Type 3R
 4 = Type 4
 X = Type 4, 4X stainless steel
 P = Type 3R, 4, 4X plastic
 K = Type 3R, 12 plastic
 E = European rated IP65,
 7 = Type 7 & 9 Class I; Div. 1 & 2; Group C, & D
 Class II; Div. 1 & 2; Group E, F, & G
 74 = Type 4, 7, & 9
 * = Special customer requirements

Accessories

10 = 1 N.O. auxiliary contact
 01 = 1 N.C. auxiliary contact
 11 = 1 N.O. & 1 N.C. auxiliary contacts
 22 = 2 N.O. & 2 N.C. auxiliary contacts
 A = Start/Stop pushbuttons
 C = 2 Position selector switch
 D = 3 Position selector switch
 E = Pilot light, "Red/Run"
 N = Neutral terminal
 G = Ground terminal, isolated ①
 U = Service entrance, 3-wire ②
 V = Service entrance, 4-wire
 * = Special customer requirements

Series

Handle type

the appropriate handle is provided for each enclosure in accordance with the application.

B_ = black
 Y_ = Red/Yel

Poles or conversion mechanisms

2P = 2 poles 3T = 3 pole transfer
 3P = 3 poles 4T = 4 pole transfer
 4P = 4 poles 3B = 3 pole by-pass
 6P = 6 poles 3M = 3 pole mechanical interlock

OSHA

Suitable for use as OSHA Lockout/tagout disconnect when applied in accordance with part IV, Department of Labor Occupational Safety and Health Administrations, 29 CFR Part 1910, Control of Hazardous Energy Source (Lockout/Tagout): Final Rule.

17

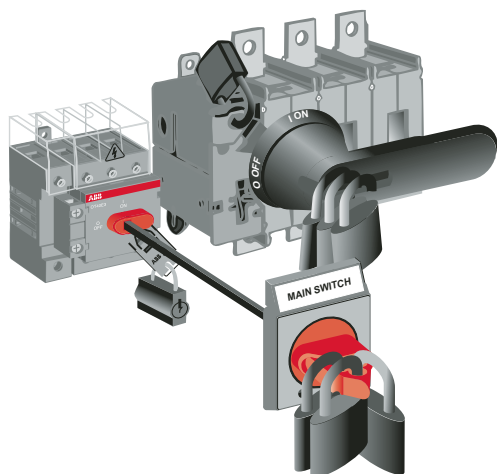

Handle and mechanism padlocked OFF

Padlockable

Handles can be padlocked in the "OFF" position with up to three padlocks: Additionally, the switch mechanism can be directly padlocked in the "OFF" position when the door is open. NOTE: Some handles can be ordered with the ability to padlock in both the "ON" & "OFF" positions, please consult your ABB sales office. When the handle is padlocked, the enclosure cannot be opened.

① All enclosed switches are provided with a ground lug. See page 17.139.
 ② Only for UL 98 switches

General information Non-Fusible and Fusible

Disconnect
switches
Non-fusible
Enclosed

Non-Fusible

UL Listed to UL 508 and UL 98.
CSA approved
IEC rated
CE marked

Snap on accessories include additional poles, auxiliary contacts, etc.

Enclosures available in plastic, metal, or stainless steel in NEMA 1, 3R, 12, 4X, 7 & 9 environmental categories

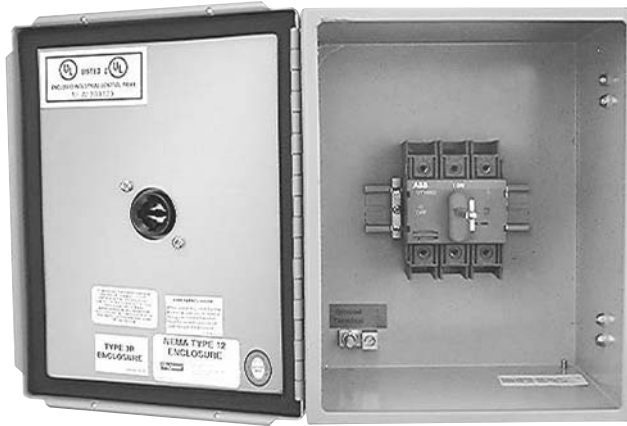

Modern appearance

Quick make, quick brake mechanism

Heavy duty disconnect, 600VAC

Extremely compact size

Finger-proof construction. No hazardous exposed parts

3/4/6/8 pole constructions; transfer switches and by-pass switches available

Fusible

UL Listed to UL 98 standards.
CSA approved
IEC rated
CE marked

Snap on accessories include fuse monitors, auxiliary contacts, etc.

Enclosures available in plastic, metal, or stainless steel in NEMA 1, 3R, 12, 4X, 7 & 9 environmental categories

Fuse carriers available for US standards, BS, DIN, NFC standard and for various high speed fuse patterns



Modern appearance

Quick make, quick brake mechanism

Heavy duty disconnect, 600VAC, 200kA, I_{sc}

Extreme compact size as fuse carriers are decked above contacts

Double contacts enabling feed from any direction and preventing back feed

Finger-proof construction. No hazardous exposed parts

3/4/6/8 pole constructions; transfer switches and by-pass switches available

Lockable

Clear position indications:
I-ON
O-OFF

Door interlocked when handle padlocked to OFF position

Handle padlockable with up to three padlocks

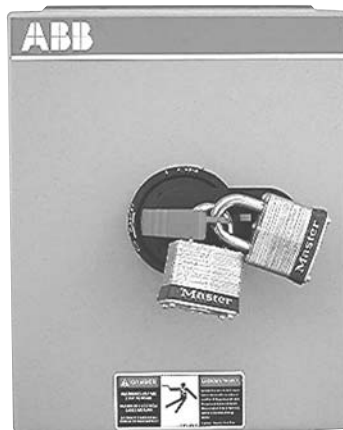

Door interlocked when handle is in ON position. Door interlock can be defeated by authorized personnel.

Pilot devices can be added

General information

NEMA Environmental ratings

Introduction

An enclosure is a surrounding case constructed to provide a degree of protection to personnel against accidental contact with the enclosed equipment and to provide a degree of protection to the enclosed equipment against specified environmental conditions.

A brief description of the more common types of enclosures used by the electrical industry relating to their environmental capabilities follows.

Refer to NEMA Standards Publication for more information regarding applications, features and design tests.

Individual NEMA product Standards Publications or third party certification standards may contain additional requirements for product testing and performance.

Definitions pertaining to nonhazardous locations

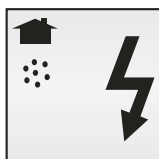

Type 1

Enclosures are intended for indoor use primarily to provide a degree of protection against limited amounts of falling dirt. (NEMA Standard 7-15-1991.)

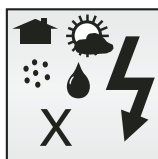

Type 4X

Enclosures are intended for indoor or outdoor use primarily to provide a degree of protection against corrosion, windblown dust and rain, splashing water, hose-directed water and damage from external ice formation. (NEMA Standard 1-10-1979)

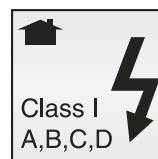

Type 7

Enclosures are intended for indoor use in locations classified as Class I, Groups, A, B, C, or D, as defined in the National Electrical Code. (NEMA Standard 7-15-1991.)

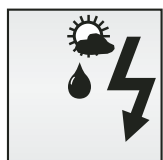

Type 3R

Enclosures are intended for outdoor use primarily to provide a degree of protection against rain, sleet and damage from external ice formation. (NEMA Standard 7-15-1991.)



Type 12

Enclosures are intended for indoor use primarily to provide a degree of protection against circulating dust, falling dirt, and dripping noncorrosive liquids. (NEMA Standard 7-15-1991.)

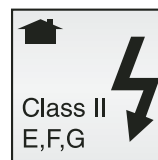

Type 9

Enclosures are intended for indoor use in locations classified as Class II, Groups E, F, or G, as defined in the National Electrical Code. (NEMA Standard 7-15-1991.)

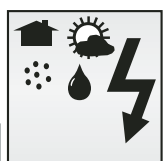

Type 4

Enclosures are intended for indoor or outdoor use primarily to provide a degree of protection against windblown dust and rain, splashing water, hose-directed water and damage from external ice formation. (NEMA Standard 1-10-1979.)



Type 13

Enclosures are intended for indoor use primarily to provide a degree of protection against dust, spraying of water, oil and noncorrosive coolant. (NEMA Standard 1-10-1979.)

Legend

- Indoors
- Outdoors
- Water
- Dirt/dust
- Corrosion





















General information

IP Environmental ratings

Disconnect
switches
Non-fusible
Enclosed

IP ratings

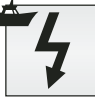
indicate the degree of protection against dust, liquids and impacts. The IP degrees of protection are defined by the French standard NFC 20-010. To rate a device's degrees of protection, the letters IP are followed by up to three numbers. These numbers are defined as follows:

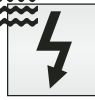
first number protection against solid objects	second number protection against liquids	third number protection against mechanical impacts
<p>IP 0  no protection</p>	<p>IP 0  no protection</p>	<p>IP 0  no protection</p>
<p>1  protected against solid objects over 50mm (e.g. accidental touch by hands.)</p>	<p>1  protected against vertically falling rain or condensation</p>	<p>1  impact 0.225 joule 150g falling from 15cm</p>
<p>2  protected against solid objects over 12mm (e.g. fingers)</p>	<p>2  protected against direct sprays of water up to 15° from vertical</p>	<p>2  impact 0.375 joule 250g falling from 15cm</p>
<p>3  protected against solid objects over 2.5mm (tools & wires)</p>	<p>3  protected against sprays to 60° from vertical</p>	<p>3  impact 0.50 joule 250g falling from 20cm</p>
<p>4  protected against solid objects over 1mm (small tools & small wires)</p>	<p>4  protected against water sprayed from all directions</p>	<p>5  impact 2.00 joule 500g falling from 40cm</p>
<p>5  protected against dust (no harmful deposit)</p>	<p>5  protected against low pressure jets of water from all directions</p>	<p>7  impact 6.00 joule 1.5kg falling from 40cm</p>
<p>6  totally protected against dust</p>	<p>6  protected from strong jets of water (e.g. for use on ship decks)</p>	<p>9  impact 20.00 joule 5 kg falling from 40cm</p>
	<p>7  protected against the effects of immersion between 15cm and 1m</p>	

**Disconnect
switches**
Non-fusible
Enclosed

3 pole 16A – 3150A



NF321-3PBJA



NF63X-3PB6A

3 Pole, 600V, 16A – 80A Selector handle

UL general purpose amp rating		NEMA Enclosure type							
		1		3R		4		4X Stainless	
		Catalog number	List price	Catalog number	List price	Catalog number	List price	Catalog number	List price
UL 508		NF161-3PBJA	\$ 185	NF163-3PBJA	\$ 259	Not available with selector handle		Not available with selector handle	
		NF251-3PBJA	190	NF253-3PBJA	264				
		NF321-3PBJA	205	NF323-3PBJA	279				
		NF451-3PBJB	245	NF453-3PBJB	320				
		NF631-3PBJA	280	NF633-3PBJA	354				

3 Pole, 600V, 16A – 3150A Pistol handle

UL general purpose amp rating		NEMA Enclosure type							
		1		3R		4		4X Stainless	
		Catalog number	List price	Catalog number	List price	Catalog number	List price	Catalog number	List price
UL 508		NF161-3PB6A	\$ 235	NF163-3PB6A	\$ 309	NF164-3PB6A	\$ 475	NF16X-3PB6A	\$ 585
		NF251-3PB6A	240	NF253-3PB6A	314	NF254-3PB6A	480	NF25X-3PB6A	590
		NF321-3PB6A	255	NF323-3PB6A	329	NF324-3PB6A	495	NF32X-3PB6A	605
		NF451-3PB6B	295	NF453-3PB6B	370	NF454-3PB6B	525	NF45X-3PB6B	635
		NF631-3PB6A	330	NF633-3PB6A	404	NF634-3PB6A	550	NF63X-3PB6A	660
UL 98		NF301-3PB6B	510	NF303-3PB6B	780	NF304-3PB6B	1090	NF30X-3PB6B	1200
		NF601-3PB6B	560	NF603-3PB6B	830	NF604-3PB6B	1140	NF60X-3PB6B	1250
		NF1001-3PB6B	610	NF1003-3PB6B	880	NF1004-3PB6B	1190	NF100X-3PB6B	1300
		NF1251-3PB6A	1100	NF1253-3PB6A	1400	NF1254-3PB8A	2800	NF125X-3PB8A	3500
		NF2001-3PB8A	1300	NF2003-3PB8A	1650	NF2004-3PB8A	3520	NF200X-3PB8A	4400
		NF4001-3PB4A	2600	NF4003-3PB4A	2800	NF4004-3PB4A	6400	NF400X-3PB4A	8000
		NF6001-3PB4A	4800	NF6003-3PB4A	5000	NF6004-3PB4A	9600	NF600X-3PB4A	12,000
		NF8001-3PB4A	8000	NF8003-3PB4A	9400	NF8004-3PB4A	15,200	NF800X-3PB4A	19,000
		NF12001-3PB4A	10,000	NF12003-3PB4A	11,800	NF12004-3PB4A	18,000	NF1200X-3PB4A	22,500
		NF16001-3P8A	19,000	NF16003-3P8A	20,800	NF16004-3P8A	30,400	NF1600X-3P8A	38,000
		NF20001-3P8A	23,000	NF20003-3P8A	25,000	NF20004-3P8A	35,200	NF2000X-3P8A	44,000
		NF31501-3P8A	28,000	NF31503-3P8A	30,000	NF31504-3P8A	39,200	NF3150X-3P8A	49,000

NOTE: All enclosed switches are provided with a black handle; however, most handles can be substituted with a red and yellow handle if desired. Please substitute the handle suffix code (2nd and 3rd from last characters) with the red/yellow handle catalog number suffix from page 17.126. There is no additional price adder for changing to a red/yellow handle of equal ratings and style.

EXAMPLE: A red/yellow selector handle for an NF161-3PBJA can be substituted for the black selector handle by using the "YJ" suffix instead of the "BJ" suffix, new catalog #NF161-3PYJA.

① Enclosures are rated as listed, selector handles are only NEMA rated 1, 3R, 12. The overall NEMA rating of an enclosed switch with a selector handle is 1, 3R, 12.
② IEC rated only.

3 pole 16A – 3150A

Disconnect
switches
Non-fusible
Enclosed

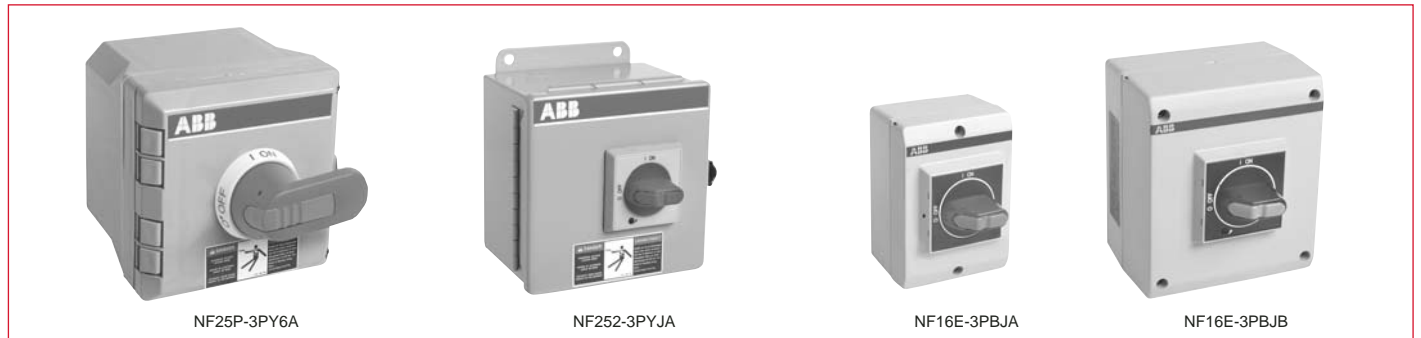

3 Pole, 600V, 16A – 80A Selector handle

UL general purpose amp rating	NEMA Enclosure type						IEC Enclosure type		
	12 Plastic		12		7 & 9		IP65 Plastic / NEMA 3R & 12		
	Catalog number	List price	Catalog number	List price	Catalog number	List price	Catalog number	List price	
UL 508 	16	NF16P-3PBJA	\$ 295	NF162-3PBJA	\$ 259	—	—	NF16E-3PBJA	\$ 185
	16, oversize	—	—	—	—	—	—	NF16E-3PBJB	210
	25	NF25P-3PBJA	300	NF252-3PBJA	264	—	—	NF25E-3PBJA	190
	25, oversize	—	—	—	—	—	—	NF25E-3PBJB	215
	40	NF32P-3PBJA	315	NF322-3PBJA	279	—	—	NF32E-3PBJA	225
UL 508	40, oversize	—	—	—	—	—	—	NF32E-3PBJB	230
	60	NF45P-3PBJB	350	NF452-3PBJB	320	—	—	NF45E-3PBJA	245
	80	NF63P-3PBJA	380	NF632-3PBJA	354	—	—	NF63E-3PBJA	275

3 Pole, 600V, 16A – 3150A Pistol handle

UL general purpose amp rating	NEMA Enclosure type						IEC Enclosure type		
	4X Plastic		12		7 & 9		IP65 Plastic / NEMA 4X		
	Catalog number	List price	Catalog number	List price	Catalog number	List price	Catalog number	List price	
UL 508 	16	NF16P-3PB6A	\$ 345	NF162-3PB6A	\$ 309	NF167-3P	\$ 1350	NF16E-3PB4B	\$ 235
	25	NF25P-3PB6A	350	NF252-3PB6A	314	NF257-3P	1375	NF25E-3PB4B	240
	40	NF32P-3PB6A	365	NF322-3PB6A	329	NF327-3P	2000	NF32E-3PB4B	255
	60	NF45P-3PB6B	400	NF452-3PB6B	370	NF457-3P	2100	NF45E-3PB4B	295
UL 98 	80	NF63P-3PB6A	430	NF632-3PB6A	400	NF637-3P	2400	NF63E-3PB4B	325
	30	NF30P-3PB6B	875	NF302-3PB6B	780	NF307-3P	2800	NF30E-3PB6A	560
	60	NF60P-3PB6B	925	NF602-3PB6B	830	NF607-3P	2850	NF60E-3PB6A	610
	100	NF100P-3PB6B	975	NF1002-3PB6B	880	NF1007-3P	2900	NF100E-3PB6A	660
	125	NF125P-3PB8A	3000	NF1252-3PB6A	1400	NF1257-3P	4000	NF125E-3PB6A	1100
	200	NF200P-3PB8A	4000	NF2002-3PB8A	1600	—	—	—	—
	400	NF400P-3PB4A	6000	NF4002-3PB4A	2900	—	—	—	—
	600	NF600P-3PB4A	10,000	NF6002-3PB4A	5100	—	—	—	—
	800	NF800P-3PB4A	16,000	NF8002-3PB4A	8400	—	—	—	—
	1200	NF1200P-3PB4A	19,000	NF12002-3PB4A	10,400	—	—	—	—
	1600	NF1600P-3P8A	31,000	NF16002-3P8A	19,400	—	—	—	—
	2000	NF2000P-3P8A	37,000	NF20002-3P8A	23,400	—	—	—	—
3150 ^②	NF3150P-3P8A	42,000	NF31502-3P8A	28,400	—	—	—	—	

① Please consult factory for pricing and availability
② IEC rated only.

**Disconnect
switches**
Non-fusible
Enclosed

Switch ratings, handle ratings 16A – 3150A

Switch ratings, 16 – 3150 Amps, 600V

UL General purpose amp rating	Maximum horsepower rating							Wire size for terminal lugs	For wire type	Approval
	Single phase			Three phase						
	120V	200V	240V	200V – 208V	240V	480V	600V			
UL 508 16 25 40	1	2	2	3	5	10	10	#18 – 8	Cu	CSA, UL
	1.5	3	3	7.5	7.5	15	20	#18 – 8	Cu	CSA, UL
60 80	2	5	5	15	15	30	30	#14 – 1	Cu	CSA, UL
	2	5	5	20	20	40	40	#14 – 1	Cu	CSA, UL
UL 98 30 60 100	2	5	5	10	10	20	30	#14 – 4	Cu	CSA, UL
	3	7.5	7.5	20	20	40	40	#14 – 4	Cu	CSA, UL
	5	15	15	25	30	50	50	#8 – 1/0	Cu	CSA, UL
	125	20	20	30	30	75	100	#8 – 1/0	Cu	CSA, UL
600 800 1200	—	—	—	150	200	400	500	(2) #2 – 600 kcmil	Cu	CSA, UL
	—	—	—	200	250	500	600	(2) #2 – 600 kcmil	Cu/Al	CSA, UL
	—	—	—	—	—	—	—	(4) #2 – 600 kcmil	Cu/Al	CSA, UL
	—	—	—	—	—	—	—	(4) #2 – 600 kcmil	Cu/Al	CSA, UL
1600 2000 3150 ①	—	—	—	—	—	—	—	(8) #2 – 600 kcmil	Cu/Al	CSA, UL
	—	—	—	—	—	—	—	(8) #2 – 600 kcmil	Cu/Al	IEC

Handle ratings, 16 – 3150 Amps, 600V

Amperage range	Style type	NEMA	Color	Marking	Defeatable	Padlockable	Catalog number suffix	Catalog number
16 – 100	Selector	1,3R,12	Black	O/I & OFF/ON	Yes	Yes	BJ	OHB2AJ
	Selector	1,3R,12	Red/Yel				YJ	OHY2AJ
	Pistol	1,3R,12	Black				B6	OHB65J5
	Pistol	1,3R,12	Red/Yel				Y6	OHY65J5
	Pistol	1,3R,4,4X,12	Black				B6	OHB65L5
	Pistol	1,3R,4,4X,12	Red/Yel				Y6	OHY65L5
125	Pistol	1,3R,12	Black	O/I & OFF/ON	Yes	Yes	B6	OHB65J6
		1,3R,12	Red/Yel				Y6	OHY65J6
		1,3R,4,4X,12	Black				B8	OHB80L6
		1,3R,4,4X,12	Red/Yel				Y8	OHY80L6
200	Pistol	1,3R,12	Black	O/I & OFF/ON	Yes	Yes	B8	OHB80J8
		1,3R,12	Red/Yel				Y8	OHY80J8
		1,3R,4,4X,12	Black				B8	OHB80L8
		1,3R,4,4X,12	Red/Yel				Y8	OHY80L8
400 – 3150	Pistol	1,3R,12	Black	O/I & OFF/ON	Yes	Yes	B4	OHB145J12
		1,3R,12	Red/Yel		Yes		Y4	OHY145J12
		1,3R,12	Black		Yes		B7	OHB175J12
		1,3R,12	Red/Yel		Yes		Y7	OHY175J12
		1,3R,4,4X,12	Black		Yes		B4	OHB145L12
		1,3R,4,4X,12	Red/Yel		Yes		Y4	OHY145L12
		1,3R,4,4X,12	Black		Yes		B7	OHB175L12
		1,3R,4,4X,12	Red/Yel		Yes		Y7	OHY175L12
		1,3R,4,4X,12	Metal		No		8	YASDA-8
		16 – 125	Pistol		1,3R,12 1,3R,4,4X,12		Black	I/O/II
200	Pistol	1,3R,12 1,3R,4,4X,12	Black	I/O/II	Yes	Yes	B4	OHB145J12E011 OHB145L12E011
200 – 3150	Pistol	1,3R,12	Black	I/O/II	Yes	Yes	B7	OHB175J12E011
	Pistol	1,3R,4,4X,12	Black		Yes		B7	OHB175L12E011
	Metallic	1,3R,4,4X,12	Metal		No		21	YASDA-21
	Metallic	1,3R,4,4X,12	Metal		No		6	YASDA-6

① IEC rated only.

2 pole 125A – 3150A

Disconnect
switches
Non-fusible
Enclosed

2 Pole, 600V, 125A – 3150A

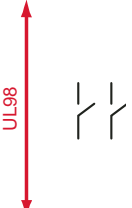
UL general purpose amp rating		NEMA Enclosure type							
		1		3R		4		4X Stainless	
		Catalog number	List price	Catalog number	List price	Catalog number	List price	Catalog number	List price
	125	NF1251-2PB6A	\$ 825	NF1253-2PB6A	\$ 1050	NF1254-2PB8A	\$ 2100	NF125X-2PB8A	\$ 2625
	200	NF2001-2PB8A	1170	NF2003-2PB8A	1485	NF2004-2PB8A	3170	NF200X-2PB8A	3960
	400	NF4001-2PB4A	2340	NF4003-2PB4A	2520	NF4004-2PB4A	5750	NF400X-2PB4A	7200
	600	NF6001-2PB4A	4320	NF6003-2PB4A	4500	NF6004-2PB4A	8640	NF600X-2PB4A	10,800
	800	NF8001-2PB4A	7200	NF8003-2PB4A	8460	NF8004-2PB4A	13,680	NF800X-2PB4A	17,100
	1200	NF12001-2PB4A	9000	NF12003-2PB4A	10,620	NF12004-2PB4A	16,200	NF1200X-2PB4A	20,250
	1600	NF16001-2P8A	17,100	NF16003-2P8A	18,720	NF16004-2P8A	27,360	NF1600X-2P8A	34,200
	2000	NF20001-2P8A	20,700	NF20003-2P8A	22,500	NF20004-2P8A	31,680	NF2000X-2P8A	39,600
	3150	NF31501-2P8A	25,200	NF31503-2P8A	27,000	NF31504-2P8A	35,280	N3150X-2P8A	44,100

2 Pole, 600V, 125A – 3150A

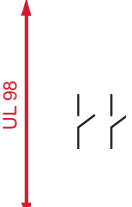
UL general purpose amp rating		NEMA Enclosure type			
		4X Plastic		12	
		Catalog number	List price	Catalog number	List price
	125	NF125P-2PB8A	\$ 2250	NF1252-2PB6A	\$ 1050
	200	NF200P-2PB8A	3600	NF2002-2PB8A	1440
	400	NF400P-2PB4A	5400	NF4002-2PB4A	2610
	600	NF600P-2PB4A	9000	NF6002-2PB4A	4590
	800	NF800P-2PB4A	14,400	NF8002-2PB4A	7560
	1200	NF1200P-2PB4A	17,100	NF12002-2PB4A	9360
	1600	NF1600P-2P8A	28,000	NF16002-2P8A	17,460
	2000	NF2000P-2P8A	33,300	NF20002-2P8A	21,060
	3150 ①	NF3150P-2P8A	37,800	NF31502-2P8A	25,560

16A – 100A switches are not available in 2 pole versions, use 3 pole.



① IEC rated only.

**Disconnect
switches
Non-fusible
Enclosed**

4 pole 16A – 3150A



4 Pole, 600V, 16A – 3150A

NEMA Enclosure type

UL general purpose amp rating	1		3R		4		4X Stainless	
	Catalog number	List price	Catalog number	List price	Catalog number	List price	Catalog number	List price
UL508 	16	NF161-4PB6A \$ 295	NF163-4PB6A \$ 369	NF164-4PB6A \$ 530	NF16X-4PB6A \$ 665			
	25	NF251-4PB6A 300	NF253-4PB6A 374	NF254-4PB6A 535	NF25X-4PB6A 670			
	40	NF321-4PB6A 310	NF323-4PB6A 384	NF324-4PB6A 545	NF32X-4PB6A 680			
UL98 	60	NF451-4PB6B 360	NF453-4PB6B 434	NF454-4PB6B 570	NF45X-4PB6B 700			
	80	NF631-4PB6A 410	NF633-4PB6A 484	NF634-4PB6A 595	NF63X-4PB6A 740			
	30	NF301-4PB6B 650	NF303-4PB6B 988	NF304-4PB6B 1200	NF30X-4PB6B 1525			
	60	NF601-4PB6B 700	NF603-4PB6B 1038	NF604-4PB6B 1250	NF60X-4PB6B 1575			
	100	NF1001-4PB6B 750	NF1003-4PB6B 1088	NF1004-4PB6B 1300	NF100X-4PB6B 1625			
	125	NF1251-4PB6A 1375	NF1253-4PB6A 1675	NF1254-4PB6A 3500	NF125X-4PB8A 4375			
	200	NF2001-4PB8A 1625	NF2003-4PB8A 2063	NF2004-4PB8A 4400	NF200X-4PB8A 5500			
	400	NF4001-4PB4A 3250	NF4003-4PB4A 3500	NF4004-4PB4A 8000	NF400X-4PB4A 10,000			
	600	NF6001-4PB4A 6000	NF6003-4PB4A 6250	NF6004-4PB4A 12,000	NF600X-4PB4A 15,000			
	800	NF8001-4PB4A 10,000	NF8003-4PB4A 11,750	NF8004-4PB4A 19,000	NF800X-4PB4A 23,750			
	1200	NF12001-4PB4A 12,500	NF12003-4PB4A 14,750	NF12004-4PB4A 22,500	NF1200X-4PB4A 28,125			
	1600	NF16001-4P8A 23,750	NF16003-4P8A 26,000	NF16004-4P8A 38,800	NF1600X-4P8A 47,500			
	2000	NF20001-4P8A 28,750	NF20003-4P8A 31,250	NF20004-4P8A 44,000	NF2000X-4P8A 55,000			
	3150 ①	NF31501-4P8A 35,000	NF31503-4P8A 37,500	NF31504-4P8A 49,000	NF3150X-4P8A 61,250			

4 Pole, 600V, 16A – 3150A

NEMA Enclosure type



UL general purpose amp rating	4X Plastic		12		7 & 9		IP65 Plastic	
	Catalog number	List price	Catalog number	List price	Catalog number	List price	Catalog number	List price
UL508 	16	NF16P-4PB6A \$ 405	NF162-4PB6A \$ 369	NF167-4P \$ 1450	NF16E-4PBJB \$ 245			
	25	NF25P-4PB6A 410	NF252-4PB6A 374	NF257-4P 1475	NF25E-4PBJB 250			
	40	NF32P-4PB6A 420	NF322-4PB6A 384	NF327-4P 2100	NF32E-4PBJB 265			
UL98 	60	NF45P-4PB6B 465	NF452-4PB6B 434	NF457-4P 2200	NF45E-4PBJA 300			
	80	NF63P-4PB6A 510	NF632-4PB6A 484	NF637-4P 2500	NF63E-4PBJA 410			
	30	NF30P-4PB6B 1100	NF302-4PB6B 925	NF307-4P 3050	NF30E-4PB4B 650			
	60	NF60P-4PB6B 1150	NF602-4PB6B 975	NF607-4P 3100	NF60E-4PB4B 700			
	100	NF100P-4PB6B 1200	NF1002-4PB6B 1025	NF1007-4P 3150	NF100E-4PB4B 750			
	125	NF125P-4PB8A 3750	NF1252-4PB6A 1750	NF1257-4P 5500	—			
	200	NF200P-4PB8A 5000	NF2002-4PB8A 2000	—	—			
	400	NF400P-4PB4A 7500	NF4002-4PB4A 3625	—	—			
	600	NF600P-4PB4A 12,500	NF6002-4PB4A 6375	—	—			
	800	NF800P-4PB4A 20,000	NF8002-4PB4A 10,500	—	—			
	1200	NF1200P-4PB4A 23,750	NF12002-4PB4A 13,000	—	—			
	1600	NF1600P-4P8A 38,500	NF16002-4P8A 24,250	—	—			
	2000	NF2000P-4P8A 46,250	NF20002-4P8A 29,240	—	—			
	3150 ①	NF3150P-4P8A 52,500	NF31502-4P8A 35,500	—	—			

① IEC rated only.



6 pole 16A – 1200A

Disconnect
switches
Non-fusible
Enclosed

6 Pole, 600V, 16A – 1200A

		NEMA Enclosure type								
		1		3R		4		4X Stainless		
UL general purpose amp rating		Catalog number	List price	Catalog number	List price	Catalog number	List price	Catalog number	List price	
UL508		16	NF161-6PB6A	\$ 580	NF163-6PB6A	\$ 728	NF164-6PB6A	\$ 1080	NF16X-6PB6A	\$ 1350
		25	NF251-6PB6A	590	NF253-6PB6A	738	NF254-6PB6A	1090	NF25X-6PB6A	1360
		40	NF321-6PB6A	610	NF323-6PB6A	758	NF324-6PB6A	1110	NF32X-6PB6A	1380
UL98		60	NF451-6PB6B	690	NF453-6PB6B	838	NF454-6PB6B	1140	NF45X-6PB6B	1430
		80	NF631-6PB6A	770	NF633-6PB6A	918	NF634-6PB6A	1185	NF63X-6PB6A	1480
		30	NF301-6PB6B	1230	NF303-6PB6B	1770	NF304-6PB6B	2110	NF30X-6PB6B	2660
		60	NF601-6PB6B	1280	NF603-6PB6B	1820	NF604-6PB6B	2160	NF60X-6PB6B	2710
		100	NF1001-6PB6B	1330	NF1003-6PB6B	1870	NF1004-6PB6B	2210	NF100X-6PB6B	2760
		125	NF1251-6PB2A	2200	NF1253-6PB2A	2800	NF1254-6PB4A	5600	NF125X-6PB4A	7000
		200	NF2001-6PB4A	2950	NF2003-6PB4A	3650	NF2004-6PB4A	7320	NF200X-6PB4A	9150
		400	NF4001-6P8A	5860	NF4003-6P8A	5960	NF4004-6P8A	13,090	NF400X-6P8A	16,360
		600	NF6001-6P8A	9960	NF6003-6P8A	10,360	NF6004-6P8A	19,490	NF600X-6P8A	24,360
		800	NF8001-6P8A	16,360	NF8003-6PB4A	19,800	NF8004-6P8A	30,690	NF800X-6P8A	38,360
1200	NF12001-6P8A	20,360	NF12003-6PB4A	23,960	NF12004-6P8A	36,290	NF1200X-6P8A	45,360		

6 Pole, 600V, 16A – 1200A

		NEMA Enclosure type								
		4X Plastic		12		7 & 9		IP65 Plastic		
UL general purpose amp rating		Catalog number	List price	Catalog number	List price	Catalog number	List price	Catalog number	List price	
UL508		16	NF16P-6PB6A	\$ 800	NF162-6PB6A	\$ 728	NF167-6P	\$ 4280	NF16E-6PB6B	\$ 410
		25	NF25P-6PB6A	810	NF252-6PB6A	738	NF257-6P	4290	NF25E-6PB6B	420
		40	NF32P-6PB6A	830	NF322-6PB6A	758	NF327-6P	4600	NF32E-6PB6B	450
UL98		60	NF45P-6PB6B	930	NF452-6PB6B	838	NF457-6P	4800	NF45E-6PB6B	520
		80	NF63P-6PB6A	1030	NF632-6PB6A	918	NF637-6P	5000	NF63E-6PB6B	770
		30	NF30P-6PB6B	1900	NF302-6PB6B	1670	NF307-6P	3050	NF30E-6PB6B	1230
		60	NF60P-6PB6B	1950	NF602-6PB6B	1720	NF607-6P	3100	NF60E-6PB6B	1280
		100	NF100P-6PB6B	2000	NF1002-6PB6B	1770	NF1007-6P	3150	NF100E-6PB6B	1330
		125	NF125P-6PB4A	6000	NF1252-6PB4A	2800	—	—	—	—
		200	NF200P-6PB4A	8350	NF2002-6PB4A	3550	—	—	—	—
		400	NF400P-6P8A	12,360	NF4002-6P8A	6160	—	—	—	—
		600	NF600P-6P8A	20,360	NF6002-6P8A	10,560	—	—	—	—
		800	NF800P-6P8A	32,360	NF8002-6P8A	17,800	—	—	—	—
1200	NF1200P-6P8A	38,360	NF12002-6P8A	21,800	—	—	—	—		

①  = Three poles

**Disconnect
switches**
Non-fusible
Enclosed

3 pole transfer switches 16A – 1200A

3 Pole, 600V, 16A – 1200A

UL general purpose amp rating		NEMA Enclosure type								
		1		3R		4		4X Stainless		
		Catalog number	List price	Catalog number	List price	Catalog number	List price	Catalog number	List price	
UL508		16	NF161-3TB8A	\$ 760	NF163-3TB8A	\$ 908	NF164-3TB8A	\$ 1200	NF16X-3TB8A	\$ 1850
		25	NF251-3TB8A	770	NF253-3TB8A	918	NF254-3TB8A	1230	NF25X-3TB8A	1880
		40	NF321-3TB8A	790	NF323-3TB8A	954	NF324-3TB8A	1260	NF32X-3TB8A	1950
UL98		60	NF451-3TB8B	870	NF453-3TB8B	1018	NF454-3TB8B	1340	NF45X-3TB8B	3500
		80	NF631-3TB8A	950	NF633-3TB8A	1098	NF634-3TB8A	1420	NF63X-3TB8A	3600
		30	NF301-3TB8B	1410	NF303-3TB8B	1830	NF304-3TB8B	2400	NF30X-3TB8B	3900
		60	NF601-3TB8B	1460	NF603-3TB8B	1880	NF604-3TB8B	2450	NF60X-3TB8B	3950
		100	NF1001-3TB8B	1510	NF1003-3TB8B	1930	NF1004-3TB8B	2500	NF100X-3TB8B	4000
		125	NF1251-3TB8A	2380	NF1253-3TB8A	2980	NF1254-3TB8A	3500	NF125X-3TB8A	5000
		200	NF2001-3TB4A	3150	NF2003-3TB4A	3850	NF2004-3TB4A	7480	NF200X-3TB4A	9350
		400	NF4001-3TB4A	5960	NF4003-3TB4A	6160	NF4004-3TB4A	13,250	NF400X-3TB4A	16,560
		600	NF6001-3TB4A	10,260	NF6003-3TB4A	10,660	NF6004-3TB4A	19,730	NF600X-3TB4A	24,660
		800	NF8001-3TB4A	16,660	NF8003-3TB4A	19,460	NF8004-3TB4A	30,920	NF800X-3TB4A	38,660
1200	NF12001-3TB4A	20,660	NF12003-3TB4A	24,260	NF12004-3TB4A	36,530	NF1200X-3TB4A	45,660		

3 Pole, 600V, 16A – 1200A

UL general purpose amp rating		NEMA Enclosure type						
		4X Plastic		12		7 & 9		
		Catalog number	List price	Catalog number	List price	Catalog number	List price	
UL508		16	NF16P-3TB8A	\$ 1000	NF162-3TB8A	\$ 908	NF167-3T	\$ 4280
		25	NF25P-3TB8A	1040	NF252-3TB8A	918	NF257-3T	4290
		40	NF32P-3TB8A	1100	NF322-3TB8A	938	NF327-3T	4300
UL98		60	NF45P-3TB8B	1180	NF452-3TB8B	1018	NF457-3T	4400
		80	NF63P-3TB8A	1260	NF632-3TB8A	1098	NF637-3T	4500
		30	NF30P-3TB8B	2000	NF302-3TB8B	1730	NF307-3T	5600
		60	NF60P-3TB8B	2050	NF602-3TB8B	1830	NF607-3T	5700
		100	NF100P-3TB8B	2100	NF1002-3TB8B	1930	NF1007-3T	5800
		125	NF125P-3TB8A	3200	NF1252-3TB8A	2980	—	—
		200	NF200P-3TB4A	8550	NF2002-3TB4A	3750	—	—
		400	NF400P-3TB4A	12,560	NF4002-3TB4A	6460	—	—
		600	NF600P-3TB4A	20,660	NF6002-3TB4A	10,760	—	—
		800	NF800P-3TB4A	32,660	NF8002-3TB4A	17,460	—	—
1200	NF1200P-3TB4A	38,660	NF12002-3TB4A	21,460	—	—		

3 pole bypass switches 16A – 1200A

**Disconnect
switches
Non-fusible
Enclosed**

3 Pole, 600V, 16A – 1200A

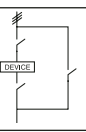
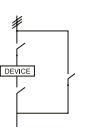
		NEMA Enclosure type								
		1		3R		4		4X Stainless		
UL general purpose amp rating		Catalog number	List price	Catalog number	List price	Catalog number	List price	Catalog number	List price	
UL508		16	NF161-3BB8A	\$ 1045	NF163-3BB8A	\$ 1267	NF164-3BB8A	\$ 1480	NF16X-3BB8A	\$ 3740
		25	NF251-3BB8A	1060	NF253-3BB8A	1282	NF254-3BB8A	1540	NF25X-3BB8A	3820
		40	NF321-3BB8A	1090	NF323-3BB8A	1297	NF324-3BB8A	1600	NF32X-3BB8A	3900
UL98		60	NF451-3BB8B	1215	NF453-3BB8B	1312	NF454-3BB8B	1750	NF45X-3BB8B	4050
		80	NF631-3BB8A	1340	NF633-3BB8A	1432	NF634-3BB8A	1850	NF63X-3BB8A	4150
		30	NF301-3BB8B	1970	NF303-3BB8B	2300	NF304-3BB8B	2800	NF30X-3BB8B	4800
		60	NF601-3BB8B	2070	NF603-3BB8B	2400	NF604-3BB8B	2900	NF60X-3BB8B	4900
		100	NF1001-3BB8B	2170	NF1003-3BB8B	2500	NF1004-3BB8B	3000	NF100X-3BB8B	5000
		125	—	—	—	—	—	—	—	—
		200	NF2001-3BB4A	4520	NF2003-3BB4A	5570	NF2004-3BB4A	11,050	NF200X-3BB4A	13,820
		400	NF4001-3B6A	8460	NF4003-3B6A	9060	NF4004-3B6A	19,750	NF400X-3B6A	24,660
		600	NF6001-3B6A	15,060	NF6003-3B6A	15,660	NF6004-3B6A	29,330	NF600X-3B6A	36,660
		800	NF8001-3B6A	24,660	NF8003-3B6A	28,860	NF8004-3B6A	46,130	NF800X-3B6A	57,660
1200	NF12001-3B6A	30,660	NF12003-3B6A	36,060	NF12004-3B6A	55,040	NF1200X-3B6A	68,800		

3 Pole, 600V, 16A – 1200A

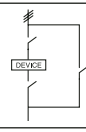
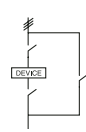
		NEMA Enclosure type				
		4X Plastic		12		
UL general purpose amp rating		Catalog number	List price	Catalog number	List price	
UL508		16	NF16P-3BB8A	\$ 1300	NF162-3BB8A	\$ 1267
		25	NF25P-3BB8A	1325	NF252-3BB8A	1282
		40	NF32P-3BB8A	1350	NF322-3BB8A	1297
UL98		60	NF45P-3BB8B	1420	NF452-3BB8B	1312
		80	NF63P-3BB8A	1550	NF632-3BB8A	1432
		30	NF30P-3BB8B	2400	NF302-3BB8B	2300
		60	NF60P-3BB8B	2500	NF602-3BB8B	2400
		100	NF100P-3BB8B	2600	NF1002-3BB8B	2500
		125	—	—	—	—
		200	NF200P-3BB4A	12,620	NF2002-3BB4A	5420
		400	NF400P-3B6A	18,660	NF4002-3B6A	9360
		600	NF600P-3B6A	30,660	NF6002-3B6A	15,960
		800	NF800P-3B6A	48,660	NF8002-3B6A	25,860
1200	NF1200P-3B6A	57,660	NF12002-3B6A	31,860		

**Disconnect
switches**
Non-fusible
Enclosed

3 pole mechanically interlocked switches 16A – 1200A

3 Pole, 600V, 16A – 1200A

		NEMA Enclosure type								
		1		3R		4		4X Stainless		
UL general purpose amp rating		Catalog number	List price	Catalog number	List price	Catalog number	List price	Catalog number	List price	
UL508		16	NF161-3MB6A	\$ 640	NF163-3MB6A	\$ 788	NF164-3MB6A	\$ 1120	NF16X-3MB6A	\$ 1410
		25	NF251-3MB6A	650	NF253-3MB6A	798	NF254-3MB6A	1160	NF25X-3MB6A	1420
		40	NF321-3MB6A	670	NF323-3MB6A	818	NF324-3MB6A	1170	NF32X-3MB6A	1440
UL98		60	NF451-3MB6B	750	NF453-3MB6B	908	NF454-3MB6B	1200	NF45X-3MB6B	1490
		80	NF631-3MB6A	830	NF633-3MB6A	978	NF634-3MB6A	1245	NF63X-3MB6A	1540
		30	NF301-3MB6B	1290	NF303-3MB6B	1830	NF304-3MB6B	2170	NF30X-3MB6B	2700
		60	NF601-3MB6B	1340	NF603-3MB6B	1880	NF604-3MB6B	2210	NF60X-3MB6B	2770
		100	NF1001-3MB6B	1390	NF1003-3MB6B	1930	NF1004-3MB6B	2270	NF100X-3MB6B	2800
		125	NF1251-3MB6A	2260	NF1253-3MB6A	2860	NF1254-3MB8A	5660	NF125X-3MB8A	7060
		200	NF2001-3MB8A	3010	NF2003-3MB8A	3710	NF2004-3MB8A	7380	NF200X-3MB8A	9210
		400	NF4001-3MB4A	5920	NF4003-3MB4A	6030	NF4004-3MB4A	13,150	NF400X-3MB4A	16,420
		600	NF6001-3MB4A	10,020	NF6003-3MB4A	10,420	NF6004-3MB4A	19,550	NF600X-3MB4A	24,420
		800	NF8001-3MB4A	16,420	NF8003-3MB4A	19,860	NF8004-3MB4A	30,750	NF800X-3MB4A	38,420
		1200	NF12001-3MB4A	20,420	NF12003-3MB4A	24,020	NF12004-3MB4A	36,350	NF1200X-3MB4A	45,420

3 Pole, 600V, 16A – 1200A

		NEMA Enclosure type				
		4X Plastic		12		
UL general purpose amp rating		Catalog number	List price	Catalog number	List price	
UL508		16	NF16P-3MB6A	\$ 860	NF162-3MB6A	\$ 788
		25	NF25P-3MB6A	870	NF252-3MB6A	798
		40	NF32P-3MB6A	890	NF322-3MB6A	818
UL98		60	NF45P-3MB6B	990	NF452-3MB6B	908
		80	NF63P-3MB6A	1090	NF632-3MB6A	978
		30	NF30P-3MB6B	1900	NF302-3MB6B	1830
		60	NF60P-3MB6B	1950	NF602-3MB6B	1880
		100	NF100P-3MB6B	2000	NF1002-3MB6B	1930
		125	NF125P-3MB8A	6000	NF1252-6PB6A	2860
		200	NF200P-3MB8A	8350	NF2002-3MB8A	3710
		400	NF400P-3MB4A	12,360	NF4002-3MB4A	6030
		600	NF600P-3MB4A	20,360	NF6002-3MB4A	10,420
		800	NF800P-3MB4A	32,360	NF8002-3MB4A	19,860
		1200	NF1200P-3MB4A	38,360	NF12002-3MB4A	24,020

Accessories ①

Disconnect
switches
Non-fusible
Enclosed

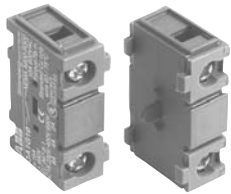

OA1G_

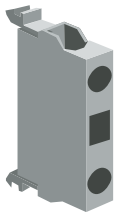

OBEA_

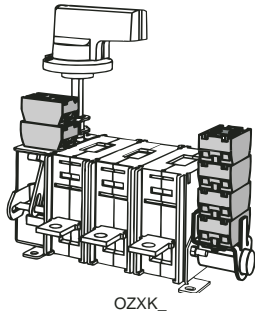

OZXK_



3 Position selector switch



Pilot light

Auxiliary contacts

For use on:	Contact configuration	Catalog number	Installation suffix	Installed list price adder
16A – 100A	1 N.O.	OA1G10	add "10" suffix	\$ 30
	1 N.C.	OA1G01	add "01" suffix	30
	1 N.O. & 1 N.C.	OA2G11	add "11" suffix	60
125A	1 N.O.	OBEA10	add "10" suffix	50
	1 N.C.	OBEA01	add "01" suffix	50
200A	1 N.O. & 1 N.C.	OZXK-12	add "11" suffix	102
	2 N.O. & 2 N.C.	OZXK-13	add "22" suffix	160
400A – 3150A	1 N.O. & 1 N.C.	OZXK-1	add "11" suffix	130
	2 N.O. & 2 N.C.	OZXK-2	add "22" suffix	200

Accessories ①

For use on:	Description	Installation suffix	Installed list price adder
OT16, 25,32 OT45, 63 OT30, 60, 100 OT160 200A – 1200A 1600A – 3150A	Neutral or isolated ground block	N or G	\$ 30
	Neutral or isolated ground block	N or G	54
	Neutral or isolated ground block	N or G	75
	Neutral or isolated ground block	N or G	150
	Neutral block	N	210
30A – 1200A 30A – 1200A	Service entrance, 3 wire	U	100
	Service entrance, 4 wire	V	200
16A – 3150A	Start/stop pushbuttons	A	68
	2 position selector switch	C	68
	3 position selector switch	D	78
	Pilot light "red/run"	E	110
	Ammeter 1 phase ②	AM	940
	Voltmeter ②	VM	2300

Ground lugs

All enclosed switches are provided with a standard integral ground lug.

Switch size	Ground lug Wire size
16A – 100A	(2) #14
200A – 400A	#6 – 250 mcm
600A – 1200A	#2 – 600 mcm
2000A – 3150A	(2) #2 – 600 mcm

① Please consult factory for special customer requirements.

② Current transformers included.

Technical data

Other configuration descriptions

Conversion mechanisms

6 or 8 pole

6 (8) pole mechanism allows two switches controlled by one handle to open or close simultaneously.

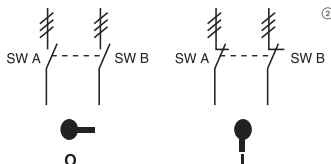

	POS. O	POS. I
SW. A	O	X
SW. B	O	X

X = Closed
O = Open

Transfer^①

Transfer mechanism manually transfers between two power sources using two switches and a center "OFF" position.

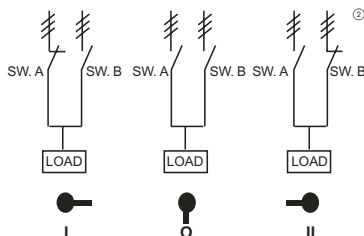

	POS. I	POS. O	POS. II
SW. A	X	O	O
SW. B	O	O	X

X = Closed
O = Open

Bypass^①

Bypass mechanism operates three switches: Two switches in series and one changeover switch to allow power bypass.

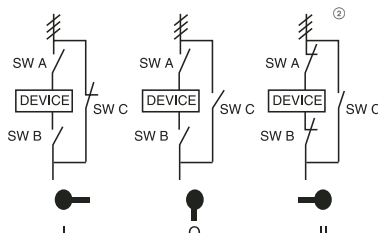

	POS. I	POS. O	POS. II
SW. A	O	O	X
SW. B	O	O	X
SW. C	X	O	O

X = Closed
O = Open

Mechanical interlock

Mechanical interlock mechanism prevents both switches from being in the ON position at the same time.

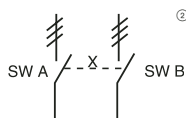

	SW. A POS. I	SW. B POS. O
SW. A	X	O
SW. B	O	X

X = Closed
O = Open

^① Transfer and bypass enclosed switches include the load side bussed or cabled together, and all switches come standard with ground lugs.

^② ≡ = Three poles

Approximate dimensions 2, 3, & 4 Pole ③ 16A – 3150A NF

Disconnect
switches
Non-fusible
Enclosed

Non-Fusible

Frame size	Enclosure type	H height	W width	D depth	MH mtg. height	MW mtg. width	Weight
OT16_ OT25_ OT32_	1	6.0	6.0	4.0	3.0	5.0	4.0
	3R	6.0	6.0	4.0	6.75	4.0	4.0
	4	6.0	6.0	4.0	6.75	4.0	4.0
	4X SS	6.0	6.0	4.0	6.75	4.0	4.0
	4X Plastic	6.0	6.0	5.9	6.75	4.0	4.0
	12	6.0	6.0	4.0	6.75	4.0	4.0
	IP65 (A)	4.8	3.4	2.4	4.17	2.80	1.0
IP65 (B)	5.9	5.1	2.4	5.35	4.57	1.0	
OT45_ OT63_ OT30_ OT60_	1	8.0	6.0	4.0	7.0	5.0	6.0
	3R	8.0	6.0	4.0	8.75	4.0	6.0
	4	8.0	6.0	4.0	8.75	4.0	6.0
	4X SS	8.0	6.0	4.0	8.75	4.0	6.0
	4X Plastic	8.0	6.0	5.9	8.75	4.0	6.0
	12	8.0	6.0	4.0	8.75	4.0	6.0
	IP65 (A)	7.9	5.7	3.6	7.24	5.16	4.0
IP65 (B)	15.8	7.9	5.5	14.8	6.93	4.0	
OT100	1	10.0	8.0	6.0	7.0	7.0	9.0
	3R	10.0	8.0	6.0	10.75	6.0	9.0
	4	10.0	8.0	6.0	10.75	6.0	9.0
	4X SS	10.0	8.0	6.0	10.75	6.0	9.0
	4X Plastic	10.0	8.0	5.9	10.75	6.0	9.0
	12	10.0	8.0	6.0	10.75	6.0	9.0
	IP65 (A)	7.9	5.7	3.6	7.24	5.16	4.0
IP65 (B)	15.8	7.9	5.5	14.8	6.93	4.0	
OT160	1	14.0	12.0	8.0	11.0	9.0	20
	3R	14.0	12.0	8.0	14.75	10.0	20
	4	14.0	12.0	8.0	14.75	10.0	20
	4X SS	14.0	12.0	8.0	14.75	10.0	20
	4X Plastic	14.0	12.0	8.0	14.75	10.0	12
	12	14.0	12.0	8.0	14.75	10.0	20

Frame size	Enclosure type	H height	W width	D depth	mtg. height	MW mtg. width	Weight
OETL-NF175 OETL-NF200A	1	24.0	16.0	8.0	25.5	14.5	50
	3R	24.0	16.0	8.0	25.5	14.5	50
	4	24.0	16.0	8.0	25.5	14.5	50
	4X SS	24.0	16.0	8.0	25.5	14.5	50
	4X Plastic	24.0	16.0	10.0	25.5	14.5	40
	12	24.0	16.0	8.0	25.5	14.5	50
OETL-NF400 OETL-NF600	1	44.0	22.0	11.0	45.5	20.5	120
	3R	44.0	22.0	11.0	45.5	20.5	120
	4	①	①	①	①	①	①
	4X SS	42.0	36.0	12.0	43.5	34.5	130
	4X Plastic	①	①	①	①	①	①
	12	44.0	22.0	11.0	45.5	20.5	120
OETL-NF800A OETL-NF1200	1	60.0	36.0	12.0	61.5	34.5	200
	3R	60.0	36.0	12.0	61.5	34.5	200
	4	60.0	36.0	12.0	61.5	34.5	200
	4X SS	60.0	36.0	12.0	61.5	34.5	200
	4X Plastic	①	①	①	①	①	①
	12	60.0	36.0	12.0	61.5	34.5	200
OETL-NF1600 OETL-NF2000 OETL-NF3150	1	90.0	36.0	24.0	(2)	(2)	600
	3R	90.0	36.0	24.0	(2)	(2)	600
	4	①	①	①	①	①	①
	4X SS	①	①	①	①	①	①
	4X Plastic	①	①	①	①	①	①
	12	90.0	36.0	24.0	②	②	600

- ① Please consult factory, enclosures are sized to suit specific customer needs.
- ② Enclosure is free standing.
- ③ Some 4-pole switches require larger enclosures. Please consult factory.

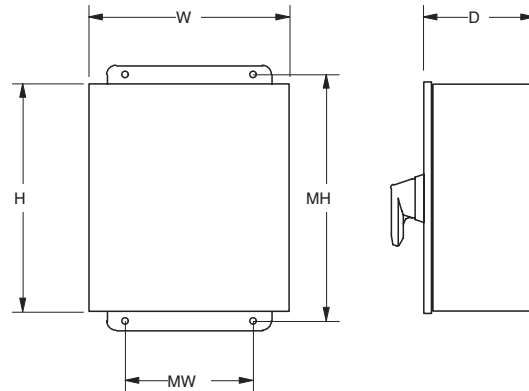

Approximate dimensions for enclosed 6-pole transfer & mechanical interlock switches 16A – 3150A NF

Non-Fusible

Frame size	Enclosure type	H height	W width	D depth	MH mtg. height	MW mtg. width	Weight (lbs.)
OT16 OT25 OT32	1	6.0	6.0	4.0	3.0	5.0	4.0
	3R	6.0	6.0	4.0	6.75	4.0	4.0
	4	6.0	6.0	4.0	6.75	4.0	4.0
	4X SS	6.0	6.0	4.0	6.75	4.0	4.0
	4X Plastic	6.0	6.0	5.9	6.75	4.0	4.0
	12	6.0	6.0	4.0	6.75	4.0	4.0
	IP65 (A)	5.9	5.1	3.4	5.35	4.57	1.2
	IP65 (B)	–	–	–	–	–	–
OT45 OT63	1	10.0	8.0	6.0	7.0	7.0	6.0
	3R	10.0	8.0	6.0	10.75	6.0	6.0
	4	10.0	8.0	6.0	10.75	6.0	6.0
	4X SS	10.0	8.0	6.0	10.75	6.0	6.0
	4X Plastic	10.0	8.0	7.9	10.75	6.0	6.0
	12	10.0	8.0	6.0	10.75	6.0	6.0
	IP65 (A)	7.9	5.7	4.0	7.18	5.10	1.5
	IP65 (B)	–	–	–	–	–	–
OT30 OT60 OT100	1	10.0	8.0	6.0	7.0	7.0	9.0
	3R	10.0	8.0	6.0	10.75	6.0	9.0
	4	10.0	8.0	6.0	10.75	6.0	9.0
	4X SS	10.0	8.0	6.0	10.75	6.0	9.0
	4X Plastic	10.0	8.0	7.9	0.0	0.0	9.0
	12	10.0	8.0	6.0	10.75	6.0	9.0
	IP65 (A)	–	–	–	–	–	–
	IP65 (B)	–	–	–	–	–	–
OT160	1	14.0	12.0	8.0	11.0	9.0	20
	3R	14.0	12.0	8.0	14.75	10.0	20
	4	14.0	12.0	8.0	14.75	10.0	20
	4X SS	14.0	12.0	8.0	14.75	10.0	20
	4X Plastic	14.0	12.0	8.0	0.0	0.0	20
	12	14.0	12.0	8.0	14.75	10.0	20

- ① Please consult factory; enclosures can be custom sized to suit specific needs
- ② Enclosure is free standing.

Frame size	Enclosure type	H height	W width	D depth	MH mtg. height	MW mtg. width	Weight (lbs.)
OETL-NF175 OETL-NF200A	3R	24.0	24.0	10.0	25.5	22.5	60
	4	24.0	24.0	10.0	25.5	22.5	60
	4X SS	24.0	24.0	10.0	25.5	22.5	60
	4X Plastic	24.0	16.0	10.0	25.5	22.5	60
	12	24.0	24.0	10.0	25.5	22.5	60
OETL-NF400 OETL-NF600A	1	48.0	36.0	12.0	49.5	34.5	160
	3R	48.0	36.0	12.0	49.5	34.5	160
	4	48.0	36.0	12.0	49.5	34.5	160
	4X SS	48.0	36.0	12.0	49.5	34.5	160
	4X Plastic	①	①	①	①	①	①
12	48.0	36.0	12.0	49.5	34.5	160	
OETL-NF800A OETL-NF1200	1	60.0	36.0	12.0	61.5	34.5	240
	3R	60.0	36.0	12.0	61.5	34.5	240
	4	60.0	36.0	12.0	61.5	34.5	240
	4X SS	60.0	36.0	12.0	61.5	34.5	240
	4X Plastic	①	①	①	①	①	①
	12	60.0	36.0	12.0	61.5	34.5	240
OETL-NF1600 OETL-NF2000 OETL-NF3150	1	90.0	36.0	24.0	②	②	600
	3R	90.0	36.0	24.0	②	②	600
	4	①	①	①	①	①	①
	4X SS	①	①	①	①	①	①
	4X Plastic	①	①	①	①	①	①
	12	90.0	36.0	24.0	②	②	600

