

Cable Management

Since 1911 Gleason Reel Corp. has been in the business of CABLE MANAGEMENT. Our products are designed to convey and protect valuable cables and hoses that power and control moving machines of all types. They improve productivity and safety on the job by moving cables and hoses away from hazardous locations on machinery or the shop floor into a controlled environment. Whether you choose Reels for efficient storage and payout from virtually any angle, Festoon Systems for overhead applications or PowerTrak® for protection on machinery in motion, your cables and/or hoses will last longer and provide better service with a cable management system from **Gleason Reel Corp. ...**
...The Cable & Hose Management Company.



Spring & Motor Driven

REELS

SERIES **SHO**
SPRING

SERIES **TMR**
MOTOR

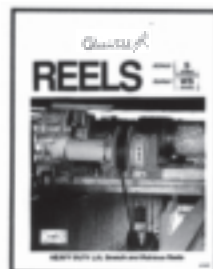

Bulletin "CR"
Heavy Duty
Spring Driven
Electric Cable Reels
General Industrial

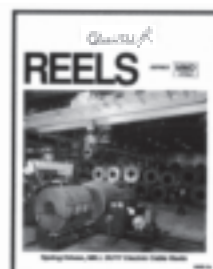

Bulletin "MMD"
Mill Duty
Spring Driven
Electric Cable Reels
Demanding Service

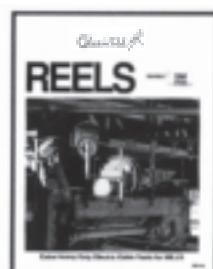

Bulletin "SM"
Heavy Mill Duty
Spring Driven
Electric Cable Reels
Steel Mill Service

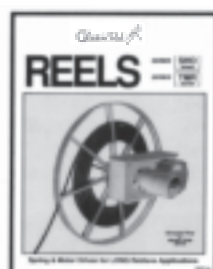

Bulletin "RET"
Long Travel Length
Spring/Motor Driven
Electric Cable Reels
Standard Industrial

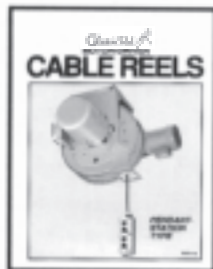

Bulletin "PSR"
Lifting & Lowering
Motor Driven
Electric Cable Reels
Push-Button Reels



Bulletin "VMR"
Large Retrieving
Motor Driven
Electric Cable Reels
Heavy Duty Industrial

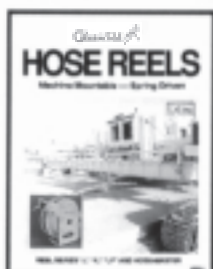

Bulletin "HRM"
Various Types
Spring-Driven
Hose Reels
General Industrial



Bulletin "SR"
Slip Rings
Unitized Design
Low & High Amperage
Low & Medium Voltage



Bulletin "PTG"
Non-metallic
Cable Chain
For Hose & Cable
Lightweight, Economical

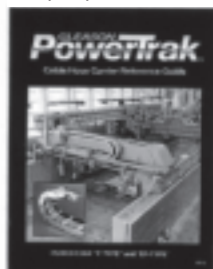

Bulletin "PT"
Rugged Steel
Cable Chain
For Cables & Hoses
Standard & Mill Duty

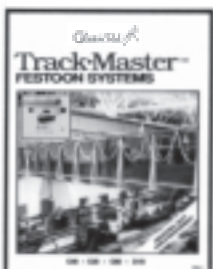

Bulletin "FC"
Flat & Round Cable
C-Rail Mounted
Festoon Systems
General Industrial



Bulletin "FB"
Heavy Duty
I-Beam Mounted
Festoon Systems
Heavy Duty Port Types

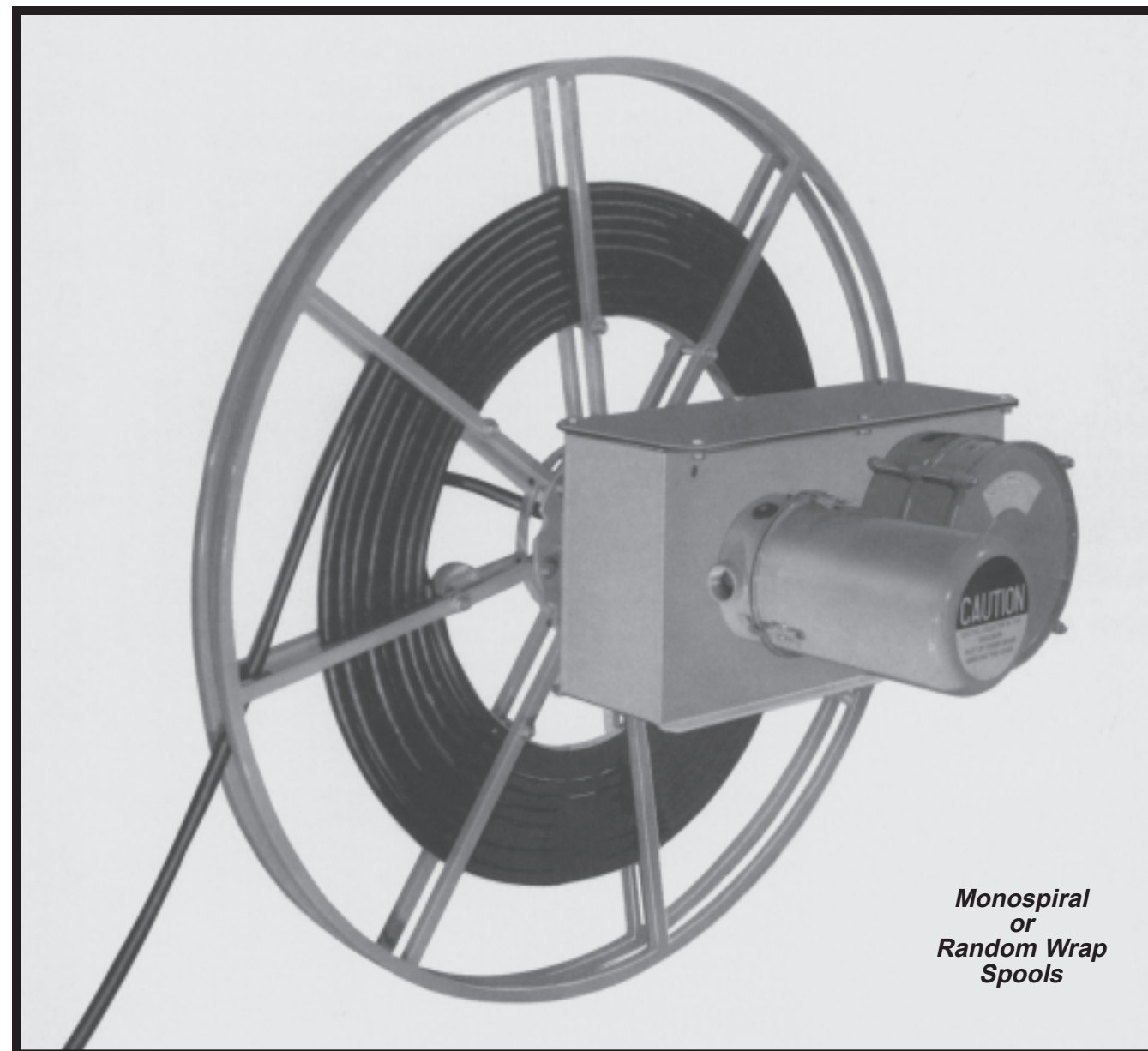

*Monospiral
or
Random Wrap
Spools*

For LONG CABLE or HOSE Retrieve Applications



Eight Steps to Reliable Production with Gleason SHO/TMR Series Reels

STEP 1 DESIGN FEATURES	<p style="text-align: center;">DESIGN FEATURES</p> <p>After familiarizing yourself with the design features of the SHO and TMR Reels, select the series reel that will best suit your application.</p>	<p style="text-align: center;">PAGES 3 - 5</p>
STEP 2 SPOOLING CONFIGURATION	<p style="text-align: center;">SPOOLING CONFIGURATION</p> <p>Determine the best spooling to meet your needs – Random Wrap or Monospiral Wrap.</p>	<p style="text-align: center;">PAGE 6</p>
STEP 3 CABLE SELECTION	<p style="text-align: center;">CABLE SELECTION</p> <p>Use the electric cable information on these pages to make your cable selection.</p>	<p style="text-align: center;">PAGES 6 - 7</p>
STEP 4 REEL MODEL SELECTION	<p style="text-align: center;">REEL MODEL SELECTION</p> <p>This page contains the necessary details needed to choose the proper reel model for your application. See pages 10 thru 16 for capacity charts.</p>	<p style="text-align: center;">PAGE 8</p>
STEP 5 CABLE CONNECTION REQUIREMENTS	<p style="text-align: center;">CABLE CONNECTION REQUIREMENTS</p> <p>To determine how much extra cable you need for connection to your selected reel, study the material on this page.</p>	<p style="text-align: center;">PAGE 8</p>
STEP 6 HOW TO ORDER	<p style="text-align: center;">HOW TO ORDER</p> <p>Complete, explicit instructions on how to order the correct reel for your requirements are detailed on this page.</p>	<p style="text-align: center;">PAGE 9</p>
STEP 7 DIMENSION DRAWINGS	<p style="text-align: center;">DIMENSION DRAWINGS</p> <p>Following selection of the proper reel, turn to these pages for exact dimensions.</p>	<p style="text-align: center;">PAGES 18 - 21</p>
STEP 8 SPECIAL APPLICATIONS	<p style="text-align: center;">SPECIAL APPLICATIONS</p> <p>Information on reels to be used in hazardous locations, corrosive atmospheres, or in applications other than horizontal retrieve are highlighted on this page.</p>	<p style="text-align: center;">PAGE 22</p>

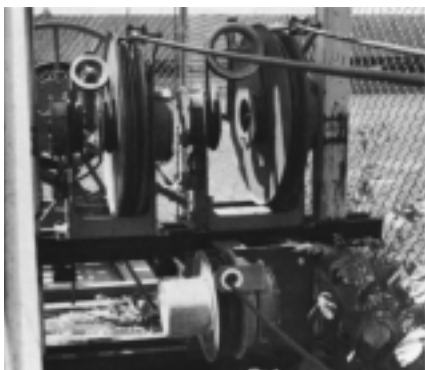

TEST FACILITIES



GLEASON PRODUCT CENTER AND PLANT – MAYVILLE, WISCONSIN



EXPERIENCED ENGINEERING STAFF

SHO/TMR Series Retrieve Type Electrical Cable Reels*

STEP 1

SHO/TMR Series Reels are designed to provide a low cost solution for long electrical cable horizontal retrieve applications.

HORIZONTAL RETRIEVE

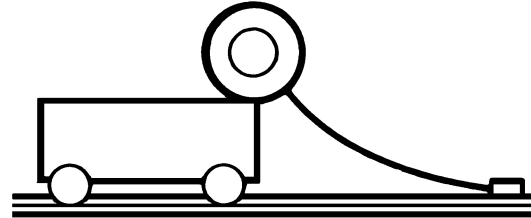

A horizontal retrieve application is when the reel is mounted on the moving equipment and winds or pays-out cable into a tray or other support.

SPRING DRIVE OR TORQUE MOTOR DRIVE

In the SHO Series Reels, winding torque is provided by one or more parallel design spring motors. The TMR Series Reels utilize a small torque motor/gear reducer to drive the spool.

RANDOM WRAP OR MONOSPIRAL WRAP SPOOLS

Both the SHO and TMR Series Reels are available with either random wrap or monospiral wrap spools.

SHO/TMR REEL CAPACITIES

Gleason SHO/TMR Series Reels have retrieve capacities to 350 feet of electric cable at a velocity of 150 ft./min. and acceleration of 1.0 ft./sec./sec.

SHO/TMR DESIGN FEATURES

SHO/TMR Series Reels are equipped with the following features:

- All Steel Construction
- Safetychange® Spring cartridges for safe, easy spring changes (SHO Series only).
- Unitized self-contained slip-ring assemblies.
- Positive spool lock for safe, easy cable replacement without removing reel from its mounting.
- Heavy duty chain drive with tension adjustment.
- Parallel spring design (SHO Series only).
- Simple, quick spring pre-tension design (SHO Series only).
- Dust-tight, watertight chain cases with gasketed and oil bath lubrication.

****SHO and TMR Series reels are also available in configurations to handle hose. Consult factory for model selection information and recommendations.***

SHO/TMR SERIES ELECTRICAL FEATURES

In addition to being unitized and self-contained, Gleason slip-ring assemblies are available in 35, 75, 125 and 200-amp capacities at 600VAC or 250VDC. Each unit runs on its own set of bearings to insure precise alignment of rings and brushes. All assemblies are equipped with terminal strips for quick and easy

electrical connection. Brushes are held in place with Gleason's exclusive spring finger design which keeps constant pressure on the brushes and permits replacement in minutes. All assemblies are continually tested and high pot tested to 2,200 volts during factory inspection to insure the highest quality.

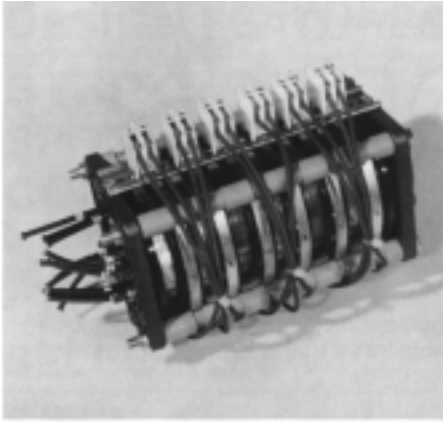

12-POLE, 35-AMP COLLECTOR

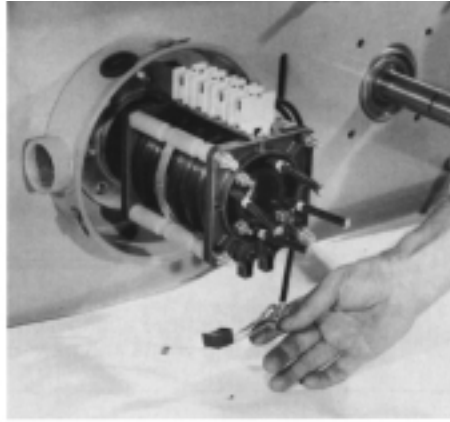

BRUSH AND FINGER ASSEMBLY

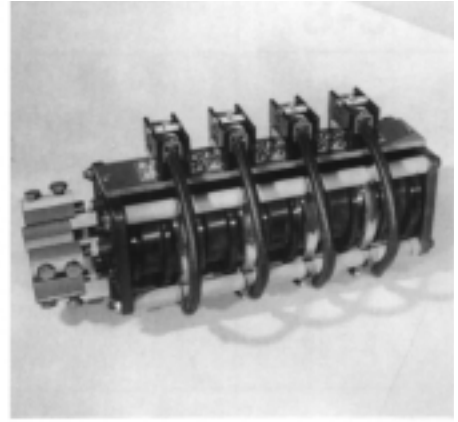

4-POLE, 200-AMP COLLECTOR

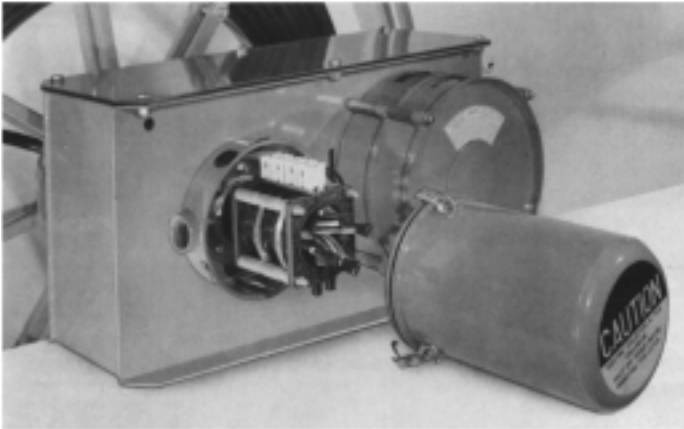

COLLECTOR COVERS

Gleason SHO/TMR Series Reels are all equipped with quick removal collector covers. Simply snap open three toggle latches and remove cover

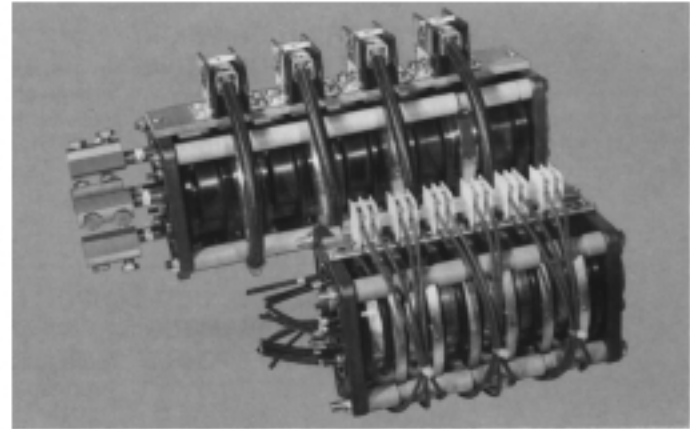

UNITIZED SLIP-RING ASSEMBLIES

Unitized slip ring assemblies are easily removed for service. In most cases, brushes can be replaced without assembly removal.

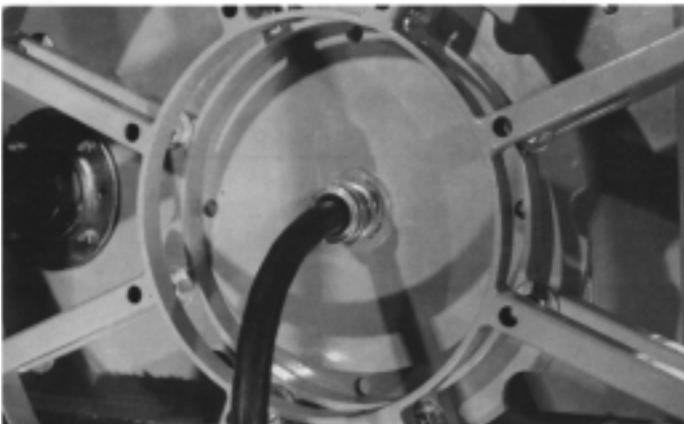

CABLE CONNECTIONS

Cables pass through watertight connector to prevent water from coming up the main shaft to the slip-ring enclosure.

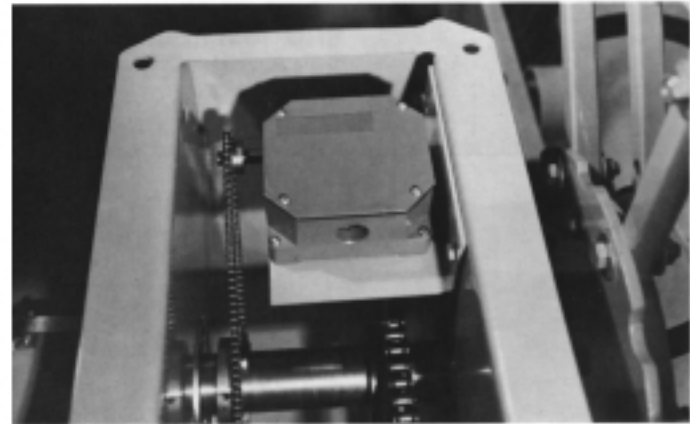

OPTIONAL ROTARY LIMIT SWITCHES

SHO/TMR Series Reels are available with an optional rotary limit switch mounted inside the dust-tight, watertight chain case. The rotary limit switch can be used to provide a signal to the moving equipment that the cable is fully extended or recovered, avoiding overtravel or undertravel.

SHO/TMR SERIES MECHANICAL FEATURES

Gleason SHO Series Spring-driven cable reels are equipped with Safetychange® spring cartridges. The Gleason spring system includes a unique free-wheeling hub designed to clutch in one direction and free-wheel in the opposite direction allowing pre-tensioning of the spring motors while cable is connected. The hub design also protects the spring against overwind in the event of a broken or severed cable. The hub simply de-clutches and free-wheels under this condition.

All springs are contained in disposable cartridges for easy handling and quick, safe replacement. Springs are simply replaced by loosening four bolts, removing pawl and pawl springs from the free-wheeling hub, and installing a new cartridge. On multiple spring designs, each spring is clutched to the spring shaft. In the event of one spring failure, the other spring(s) will maintain tension on the cable.

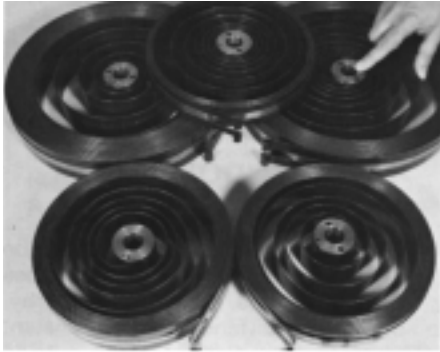

STEEL SPRINGS

All Gleason SHO Series springs are made of high quality steel and are equipped with hinges at both ends to reduce stress at mounting points, insuring maximum spring life. They are enclosed in disposable Safetychange® housings and are lifetime lubricated prior to sealing in housing.

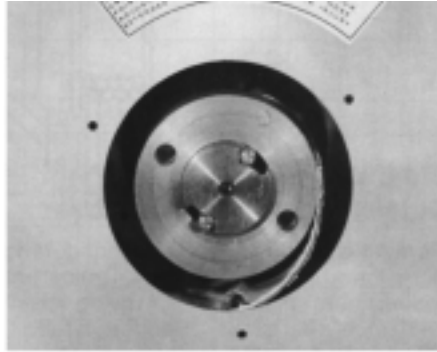

FREE-WHEELING HUB

Gleason's unique, free-wheeling spring hub design permits easy cable installation and spring tension adjustment. Also protects spring motor in event cable is severed.



SPRING TENSION ADJUSTMENT

Safe, simple spring tension adjustment. Merely remove inspection cover and pre-tension spring number of turns shown on name plate. No need to disconnect cable or disassemble reel. Spanner or ratchet wrench is provided with each reel.



SAFETYCHANGE® SPRING MOTOR

Designed with your safety in mind, Safetychange® spring motor is located outboard on frame for easy accessibility. Power spring is sealed in disposable housing. Spring motor is replaced as a unit, with no need to handle loose springs or remove reel from its mounting. All multi-spring reels are equipped with broken spring indicator buttons for visually checking spring integrity without removing spring motors while reel is in service.

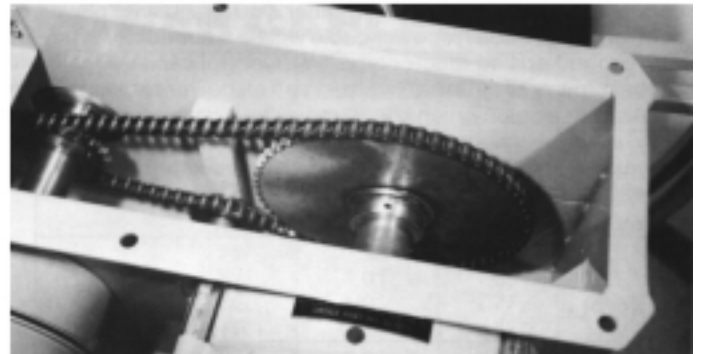

ALL STEEL CHAIN CASE

All steel chain case is dust-tight and weathertight with sealed pre-lubricated bearings. Chains are equipped with adjustable tensioners for smooth, trouble-free operation and are in a fully enclosed housing, operating in an oil bath to insure long component life. The gearing arrangement differs in the TMR Series Reels to allow full utilization of torque motor characteristics. Case is of similar construction in both SHO and TMR Series Models.

TMR SERIES MECHANICAL FEATURES

Torque motors, as used in the TMR Series Reels, provide a reliable solution to the problem of reeling long lengths of cable at the high duty cycle rates demanded by today's heavy industry. The torque motor can withstand a 100 percent stall, requiring virtually no maintenance. The motor is energized as long as the equipment is in motion, providing tension on the cable during retrieval and matching cable speed during pay-out. When the torque motor is switched off, a mechanical holding brake prevents the reel from unwinding.

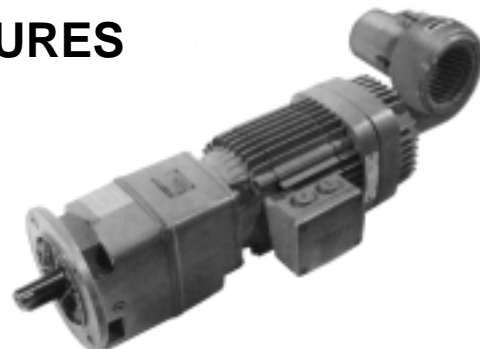

STEP 2

SPOOLING

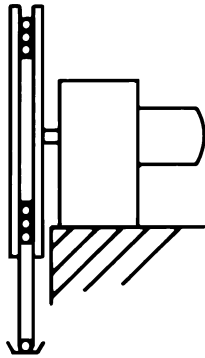

MONOSPIRAL WRAP SPOOLING

Monospiral wrap is recommended where equipment is running automatically or semi-automatically and where there are no operators near the equipment. This method requires more space for the spool given an equal amount of travel since a larger diameter is needed to accommodate the single (monospiral) wrap.

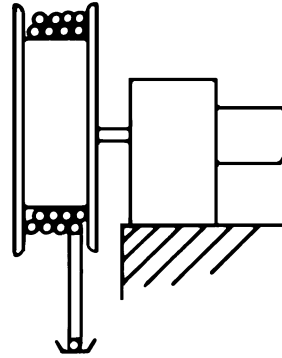

RANDOM WRAP SPOOLING

This configuration is used when the spool diameter must be small. Typical installations are on gantry cranes and other types of moving machinery where operators are usually nearby. Random wrap tends to keep the cable tension more constant over the range of spooling since core diameters and outside spool diameters differ less than on monospiral spools.

STEP 3

CABLE SELECTION

Cable selection requires that you know the number of conductors, the wire gauge and the cable length. First, identify the number of conductors, then the wire gauge. The number of conductors will depend on whether you are using power or control cable. Usually, power cable will be 3 conductor type "G" with ground or 4 conductor type "W". Control cables simply will be the number of circuits. To assist you on power cables, refer to the table on [page 7](#) which shows motor horsepower with ampere draw and wire gauge required. The other table shows weights and diameters of cable on which reel model capacity charts on [pages 10–21](#) are figured.

EXAMPLE

Suppose you have three motors operating at 460V - 3 phase totaling 40 HP. Referring to the chart on [page 7](#), find 40 HP in the horizontal row across the top of the chart. Now move vertically in the left column to locate 3 phase 460V. At the intersection point of these coordinates, you will find you require an AWG No. 6 cable with a 52 amp draw.

ACTIVE CABLE LENGTH

Active cable length is the maximum length of cable that must be wound and unwound by the reel. Active cable length depends on travel length and whether one-way or two-way payout is utilized.

ONE-WAY PAYOUT

When obstructions or environmental conditions prohibit the placement of the power source at the center of the machine travel, one-way payout (end feed) must be used. If one-way payout is used, then:

$$\text{Active Cable Length} = \text{Travel Length}$$

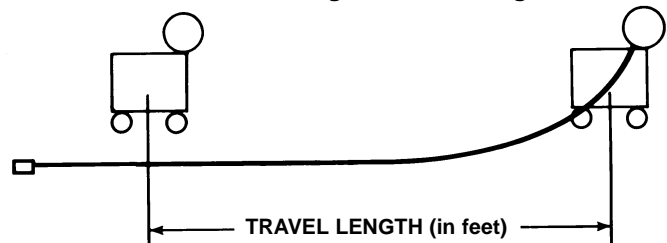

TWO-WAY PAYOUT

In many applications, the power source can be brought to the center of the machine travel for two-way payout (center feed). This permit the use of a smaller, less expensive reel and only one-half the length of cable. For example, a 200 ft. reel accommodates a travel of 400 ft. All Gleason reels are designed with two-way features as standard. If two-way payout is used, then:

$$\text{Active Cable Length} = \frac{\text{Travel Length}}{2}$$

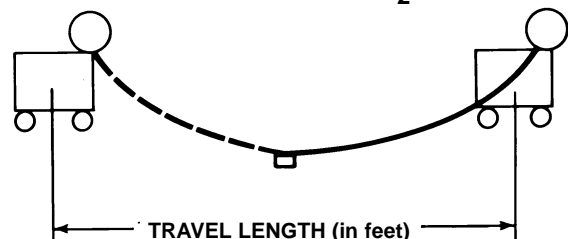

MOTOR HP AND REQUIRED WIRE SIZE

		HP	1/2	3/4	1	1-1/2	2	3	5	7-1/2	10	15	20	25	30	40	50	60	75	100		
SINGLE PHASE	115V	AMPS	9.8	13.8	16	20	24	34	56	80	100											
		WIRE SIZE	14	14	12	12	10	8	6	4	2											
	230V	AMPS	4.9	6.9	8	10	12	17	28	40	50											
		WIRE SIZE	16	16	16	14	14	12	10	8	6											
THREE PHASE	115V	AMPS	4	5.6	7.2	10.4	13.6															
		WIRE SIZE	16	16	16	14	14															
	230V	AMPS	2	2.8	3.6	5.2	6.8	9.6	15.2	22	28	42	54	68	80	104	130	154	192	248		
		WIRE SIZE	16	16	16	16	16	14	12	10	10	8	6	4	4	2	1	2/0	3/0	250		
	460V	AMPS	1	1.4	1.8	2.6	3.4	4.8	7.6	11	14	21	27	34	40	52	65	77	96	124		
		WIRE SIZE	16	16	16	16	16	16	16	14	12	10	10	8	8	6	6	4	2	1		
	575V	AMPS	.8	1.1	1.4	2.1	2.7	3.9	6.1	9	11	17	22	27	32	41	52	62	77	99		
		WIRE SIZE	16	16	16	16	16	16	16	14	14	12	10	10	8	8	6	6	4	2		
DIRECT CURRENT	120V	AMPS	5.2	7.4	9.4	13.2	17	25	40	58	76											
		WIRE SIZE	16	16	14	12	12	10	6	4	2											
	240V	AMPS	2.6	3.7	4.7	6.6	8.5	12.2	20	29	38	55	72	89	106	140	173	206	255	341		
		WIRE SIZE	16	16	16	16	14	12	10	8	6	4	4	2	1	2/0	3/0	4/0	300	500		

CONTROL CABLES

WIRE SIZE AWG	NO. OF COND.	DIAMETER (IN.)	WT./FT. (LBS.)	MIN. STRANDS/ GAUGE
No. 14	10	1.09	0.56	41/No. 30
	12	1.20	0.66	41/No. 30
	14	1.34	0.80	41/No. 30
	16	1.14	0.72	41/No. 30
	20	1.25	0.87	41/No. 30
	24	1.41	1.07	41/No. 30
	30	1.61	1.32	41/No. 30
No. 12	2	0.59	0.17	65/No. 30
	3	0.61	0.21	65/No. 30
	4	0.66	0.26	65/No. 30
	6	0.85	0.41	65/No. 30
	8	0.98	0.53	65/No. 30
	10	1.18	0.69	65/No. 30
	12	1.33	0.86	65/No. 30
	14	1.46	1.00	65/No. 30
	16	1.24	0.92	65/No. 30
	20	1.39	1.15	65/No. 30
24	1.54	1.35	65/No. 30	
No.10	2	0.64	0.22	104/No. 30
	3	0.67	0.27	104/No. 30
	4	0.72	0.34	104/No. 30
	6	0.93	0.52	104/No. 30
	8	1.11	0.72	104/No. 30
	10	1.33	0.94	104/No. 30
	12	1.46	1.10	104/No. 30
	16	1.40	1.25	104/No. 30
	20	1.54	1.52	104/No. 30

POWER CABLES

WIRE SIZE AWG	NO. OF COND.	DIAMETER (IN.)	WT./FT. (LBS.)	MIN. STRANDS/ GAUGE
NO. 8	2W	0.81	0.36	133/No. 30
	3W	0.91	0.48	133/No. 30
	3G	0.91	0.56	133/No. 30
	4W	0.99	0.63	133/No. 30
NO. 6	2W	0.93	0.50	133/No. 30
	3W	1.01	0.65	133/No. 30
	3G	1.01	0.77	133/No. 30
	4W	1.10	0.81	133/No. 30
NO. 4	2W	1.08	0.71	133/No. 30
	3W	1.17	0.95	133/No. 30
	3G	1.17	1.11	133/No. 30
	4W	1.27	1.16	133/No. 30
NO. 3	2W	1.17	0.82	259/No. 30
	3W	1.24	1.07	259/No. 30
	3G	1.24	1.20	259/No. 30
	4W	1.34	1.34	259/No. 30
NO. 2	2W	1.27	0.97	259/No. 30
	3W	1.34	1.25	259/No. 30
	3G	1.34	1.42	259/No. 30
	4W	1.48	1.62	259/No. 30
NO. 1	2W	1.44	1.21	407/No. 30
	3W	1.51	1.56	407/No. 30
	3G	1.51	1.78	407/No. 30
	4W	1.68	2.01	407/No. 30
NO. 1/0	2W	1.52	1.40	407/No. 30
	3W	1.65	1.87	407/No. 30
	3G	1.65	2.09	407/No. 30
NO. 2/0	2W	1.65	1.70	426/No. 30
	3W	1.75	2.25	426/No. 30
	3G	1.75	2.56	426/No. 30

STEP 4

REEL MODEL SELECTION

Reel model selection is based on information from the previous steps; type of reel, type of spooling, and cable requirements (number of conductors, wire gauge and active cable length). Refer to [capacity charts on page 10](#) for SHO Series Reel with Monospiral Wrap Spooling and [page 12](#) for SHO with Random Wrap. For TMR Series Monospiral Wrap, see [page 14](#) and [page 16](#) for TMR Random Wrap. To use these charts, locate the required wire gauge and number of conductors in the left hand columns and follow across to the row indicating required ACTIVE cable length (round UP to the next longer 25 ft.). Active cable length is defined as that cable which will be spooled and unspooled from the reel and does not include extra cable required for connection or safety wrap (see [STEP 5](#), below). The model charts anticipate connection cable so **DO NOT** add connection cable length to active cable length prior to using charts. USE THE MODEL NUMBER ON CHART TO ORDER REEL.

When ordering cable, however, add the active length and the connection length plus cable which may be required for connection at machine end.

NOTE: Capacities on charts based on 4 ft. lift to centerline of reel, speed of 150 ft./min., and acceleration of 1.0 ft./sec./sec. Consult factory when these specifications are exceeded or if cable lengths beyond range of charts is required.

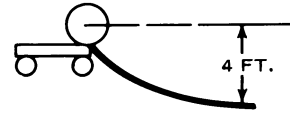

SHO MODEL NUMBER EXPLANATION

MONOSPIRAL WRAP	SHO - 80	2	-	2	7	-	18	MC	36	-	AE	-	3	
	REEL TYPE	SPRING MOTOR		NO.OF SPRINGS	NO.OF POLES		AMPACITY CODE*	DRUM DIA.	SPOOL WIDTH**		SPOOL DIA		CHAIN RATIO CODE***	PRETENSION TURNS
RANDOM WRAP	SHO - 100	1	-	4	3	-	28	4	36	-	AC	-	3	

* SLIP RING AMPACITY CODE

GLEASON CODE	MAX AMPS
3	35
7	75
12	125
20	200

** SPOOL WIDTH CODE

GLEASON CODE	WIDTH (in.)
MA	0.75
MB	1.00
MC	1.25
MD	1.50
ME	1.75
MF	2.00

SHO MODEL NUMBER EXPLANATION

MONOSPIRAL WRAP	TMR - 4	20	-	24	MF	72	-	AB	-	3	
	REEL TYPE	NO.OF POLES		AMPACITY CODE*	DRUM DIA.	SPOOL WIDTH**		SPOOL DIA		CHAIN RATIO CODE***	MOTOR SIZE
RANDOM WRAP	TMR - 10	3	-	18	7	48	-	AC	-	2	

*** CHAIN RATIO CODE

GLEASON CODE	CHAIN RATIO
AE	1.00
AD	1.50
AC	2.00
AB	2.50
AA	3.00

STEP 5

CABLE CONNECTION REQUIREMENTS

Use the table at right to determine the amount of EXTRA CABLE AT REEL (in feet) required for internal connections (cable through shaft and connection to slip ring leads) and one safety wrap. Use this information when ordering cable.

TO DETERMINE "EXTRA CABLE AT REEL": Take the DRUM DIAMETER and SLIP RING ASSEMBLY from the reel model number you have selected. The intersection of the drum diameter row and the slip ring column indicates the amount needed for your reel.

Slip Ring Assembly
Drum Dia.

Drum Dia.	EXTRA CABLE AT REEL								
14	9	9	9	9	10	10	10	10	
16	9	10	10	10	10	11	11	11	
18	10	10	11	11	11	11	12	12	
20	11	11	11	11	12	12	12	12	
22	11	12	12	12	12	13	13	13	
24	12	12	13	13	13	13	14	14	
26	13	13	13	13	14	14	14	14	
28	13	14	14	14	14	15	15	15	
30	14	14	15	15	15	15	15	16	
32	15	15	15	15	16	16	16	16	
34	15	16	16	16	16	16	17	17	
36	16	16	16	17	17	17	17	18	
23	63	47	103	412	143	203	243	303	363
33	83	212	123	420	163				
43	27	220	312						
	37	320							
Slip Ring Assembly									

HOW TO ORDER

STEP 6

Your application dictates the reel series (Step 1) and spooling required (Step 2). The cable selection (Step 3) coupled with your chosen reel series and spooling will determine the reel model most appropriate for your requirements (Step 4). To insure maximum performance and reliability, Gleason highly recommends that the electrical cable be ordered from Gleason along with the cable reel. As an added benefit, when you order cable from Gleason, the price includes installation on the reel.

When placing your order, be sure to include the following information:

- 1) Reel Model Number (Step 4)
- 2) Active Cable Length (Step 3)
- 3) Cable AWG Size and Number of Conductors (Step 3)
- 4) Optional Accessories (e.g., Rotary Limit Switch, etc.) (Step 1)
- 5) If cable is ordered, be sure to include Connection Requirements (Step 5). Total Cable Required = Active Cable Length plus Connection Requirements.
- 6) Fully specify if Special Application (Step 8)

IMPORTANT: Recheck your reel model number to insure it reflects your application needs.

EXAMPLE I

Assume you have three motors that will operate at 460V–3 phase totaling 40 HP. Your total travel length is 250 ft. Refer to the chart on page 7 and locate 40 HP in the horizontal row at the top of the chart. Next move down the left column to find 3 phase 460V. Note the draw will be 52 amps and the recommended wire size is AWG No. 6. Assume that you are unable to get power to the center of travel so you must use one-way payout. Thus, the active cable length is equal to the travel length. Now refer to the Capacity Charts for SHO Random Wrap Reels on pages 12-13 and look up conductor #6, type “G” cable. Locate the 250 ft. column and you’ll find the appropriate reel is SHO Series model SHO1003-47-32454-AC-3. If you choose the SHO Series Monospiral Wrap, refer to the chart on pages 10-11. In that case, the model number would be SHO804-47-26MC72-AE-3. This is the number you use to order so re-check it for accuracy. To order cable, you’ll need cable equal to the active cable length plus connection requirements as determined from the chart on page 8. When you order cable from Gleason, it includes installation on the reel.

EXAMPLE II

In another application, you must get 20 control conductors to a moving machine that has a travel length of 390 ft. You know you have one circuit requiring 12 amps at 115 volts and that this is the maximum ampacity for all circuits. Using the motor HP chart on page 7 for reference, you can use the single phase column at 115 volts and move horizontally to 12 amps. Since there is no 12-amp designation, use the nearest **larger** amperage or 13.8 amps. Note this occurs at 3/4 HP and the recommended wire gauge is AWG No. 14. Thus, you know you’ll need a 20 conductor #14 cable. You conclude you can center feed the application, thus two-way payout can be utilized. This reduces by one-half the cable needed for one-way payout. In addition, you can use a smaller, less expensive reel. The travel length (referring to the diagram for two-way payout on page 6) is 390 ft., with an active cable length of 195 ft. Assuming you selected SHO Series Random Wrap Reel, refer to the capacity chart on page 10. Locate the 20 conductor #14 cable in the left columns and trace horizontally to the 200 ft. column. **Note:** Since there is no 195 ft. listing, the 200 ft. category is the nearest **larger** figure and should be used rather than a lesser figure. At the intersection of these coordinates, you will find that the proper SHO Series Random Wrap reel is SHO803-203-34454-AE-4. This is the model number to use when ordering, so double-check its accuracy.



SELECTION CHART

SHO SERIES—MONOSPIRAL WRAP

WIRE SIZE	COND. NO.	100 FT.	125 FT.	150 FT.	175 FT.	200 FT.
14	10	SHO1001-103-18MC48-AE-2	SHO1001-103-22MC54-AE-2	SHO1001-103-28MC60-AE-2	SHO 802-103-26MC66-AE-6	SHO1002-103-20MC66-AD-2
	12	SHO1001-123-18MD54-AE-2	SHO1001-123-24MD60-AE-2	SHO1001-123-32MD66-AE-3	SHO1002-123-18MD66-AD-3	SHO1002-123-22MD72-AD-3
	14	SHO1001-143-20MD54-AE-2	SHO1001-143-22MD60-AE-3	SHO1002-143-18MD66-AD-4	SHO1002-143-18MD66-AD-4	SHO 803-143-20MD72-AE-6
	16	SHO1001-163-20MC54-AE-2	SHO1001-163-20MC54-AE-2	SHO1001-163-34MC66-AE-3	SHO1002-163-20MC66-AD-3	SHO1002-163-20MC66-AD-3
	20	SHO1001-203-18MD54-AE-2	SHO1001-203-24MD60-AE-3	SHO1002-203-18MD60-AD-3	SHO1002-203-20MD66-AD-4	SHO1002-203-30MD72-AD-5
	24	SHO1001-243-18ME54-AE-4	SHO1002-243-18ME60-AE-2	SHO1002-243-18ME66-AD-5	SHO 804-243-18ME72-AE-6	
12	30	SHO1002-303-18MF60-AE-2	SHO1002-303-18MF66-AE-2	SHO1002-303-28MF72-AE-3	SHO1004-303-18MF72-AD-2	
	2	SHO 801- 23-18MA42-AE-2	SHO 801- 23-18MA42-AE-2	SHO 801- 23-22MA48-AE-3	SHO 801- 23-22MA48-AE-3	SHO 801- 23-28MA54-AE-3
	3	SHO 801- 33-18MA42-AE-3	SHO 801- 33-18MA42-AE-3	SHO 801- 33-20MA48-AE-3	SHO 801- 33-20MA48-AE-3	SHO 801- 33-28MA54-AE-4
	4	SHO 801- 43-18MA42-AE-3	SHO 801- 43-18MA42-AE-3	SHO 801- 43-18MA48-AE-3	SHO 801- 43-26MA54-AE-5	SHO1001- 43-24MA54-AC-5
	6	SHO 801- 63-18MB48-AE-6	SHO 801- 63-18MB48-AE-6	SHO1001- 63-20MB54-AD-3	SHO1001- 63-28MB60-AD-4	SHO 802- 63-22MB60-AE-3
	8	SHO1001- 83-18MC48-AE-2	SHO1001- 83-18MC54-AD-4	SHO1001- 83-26MC60-AD-5	SHO 802- 83-18MC60-AE-3	SHO 802- 83-28MC66-AE-6
	10	SHO1001-103-18MD54-AE-2	SHO1001-103-24MD60-AE-2	SHO1001-103-32MD66-AE-3	SHO1002-103-18MD66-AD-3	SHO1002-103-22MD72-AD-3
	12	SHO1001-123-20MD54-AE-2	SHO1001-123-22MD60-AE-3	SHO1002-123-18MD66-AD-4	SHO1002-123-18MD66-AD-4	SHO 803-123-20MD72-AE-6
	14	SHO1001-143-22ME60-AE-4	SHO1001-143-32ME66-AE-5	SHO1002-143-20ME66-AD-4	SHO1002-143-20ME72-AD-5	
	16	SHO1001-163-20MD54-AE-3	SHO1001-163-24MD60-AE-3	SHO1002-163-18MD60-AD-3	SHO1002-163-20MD66-AD-4	SHO1002-163-30MD72-AD-5
20	SHO1001-203-18ME54-AE-4	SHO1002-203-18ME60-AE-2	SHO1002-203-20ME66-AD-5	SHO 804-203-18ME72-AE-6		
24	SHO1001-243-26ME60-AE-6	SHO1002-243-20ME66-AE-2	SHO1002-243-30ME72-AE-3			
10	2	SHO 801- 23-18MA42-AE-2	SHO 801- 23-18MA42-AE-2	SHO 801- 23-20MA48-AE-3	SHO 801- 23-20MA48-AE-3	SHO 801- 23-36MA60-AE-6
	3	SHO 801- 33-18MA42-AE-3	SHO 801- 33-18MA42-AE-3	SHO 801- 33-18MA48-AE-3	SHO 801- 33-26MA54-AE-5	SHO1001- 33-24MA54-AC-5
	4	SHO 801- 43-18MB42-AE-3	SHO 801- 43-18MB48-AE-4	SHO 801- 43-18MB48-AE-4	SHO1001- 43-24MB54-AD-2	SHO 801- 43-20MB54-AE-2
	6	SHO1001- 63-18MC48-AD-2	SHO1001- 63-20MC54-AD-4	SHO1001- 63-20MC54-AD-4	SHO 802- 63-18MC60-AE-3	SHO 802- 63-18MC60-AE-3
	8	SHO1001- 83-18MC54-AD-5	SHO1001- 83-18MC54-AD-5	SHO1001- 83-34MC66-AE-3	SHO1002- 83-22MC66-AD-3	SHO1002- 83-22MC66-AD-3
	10	SHO1001-103-20MD54-AE-2	SHO1001-103-22MD60-AE-3	SHO1002-103-18MD66-AD-4	SHO1002-103-18MD66-AD-4	SHO 804-103-18MD72-AE-3
	12	SHO1001-123-22ME60-AE-4	SHO1002-123-20ME60-AE-2	SHO1002-123-20ME66-AD-5	SHO 804-123-20ME72-AE-5	
	14	SHO1001-143-26MF60-AE-6	SHO1002-143-18MF66-AE-2	SHO1002-143-24MF72-AE-2	SHO1004-143-18MF72-AD-2	
	16	SHO1001-163-18ME54-AE-4	SHO1002-163-18ME60-AE-2	SHO1002-163-24ME66-AE-2	SHO1004-163-18ME72-AD-2	
	20	SHO1002-203-18ME60-AE-2	SHO1002-203-24ME66-AE-3	SHO1002-203-28ME72-AE-3		
8	2W	SHO 801- 27-18MB42-AE-3	SHO 801- 27-18MB48-AE-4	SHO1001- 27-18MB54-AD-2	SHO1001- 27-24MB60-AD-3	SHO 802- 27-24MB60-AE-3
	3W	SHO1001- 37-18MB48-AD-2	SHO1001- 37-18MB54-AD-3	SHO1001- 37-18MB54-AD-3	SHO 802- 37-20MB60-AE-3	SHO 802- 37-20MB60-AE-3
	3G	SHO1001- 47-18MB48-AD-3	SHO1001- 47-20MB54-AD-4	SHO1001- 47-20MB54-AD-4	SHO 802- 47-22MB60-AE-4	SHO 802- 47-22MB60-AE-4
	4W	SHO1001- 47-18MC48-AE-2	SHO1001- 47-20MC54-AD-5	SHO1001- 47-30MC60-AE-2	SHO 802- 47-20MC60-AE-5	SHO1002- 47-24MC66-AD-2
6	2W	SHO1001- 27-18MC48-AD-2	SHO1001- 27-18MC54-AD-3	SHO1001- 27-18MC54-AD-3	SHO 802- 27-18MC60-AE-3	SHO 802- 27-18MC60-AE-3
	3W	SHO1001- 37-18MC48-AE-2	SHO1001- 37-20MC54-AD-5	SHO1001- 37-30MC60-AE-2	SHO 802- 37-20MC60-AE-5	SHO1002- 37-26MC66-AD-3
	3G	SHO1001- 47-18MC48-AE-2	SHO1001- 47-24MC54-AE-2	SHO1001- 47-36MC66-AE-3	SHO1002- 47-20MC60-AD-2	SHO1002- 47-26MC66-AD-3
	4W	SHO1001- 47-18MC48-AE-2	SHO1001- 47-30MC60-AE-3	SHO1002- 47-18MC60-AD-2	SHO1002- 47-22MC66-AD-3	SHO1002- 47-22MC66-AD-3
4	2W	SHO1001-212-18MC48-AE-2	SHO1001-212-22MC54-AE-2	SHO1001-212-28MC60-AE-2	SHO1002-212-22MC66-AD-3	SHO1002-212-22MC66-AD-3
	3W	SHO1001-312-18MD54-AE-2	SHO1001-312-26MD60-AE-3	SHO1002-312-18MD60-AD-3	SHO1002-312-24MD66-AD-4	SHO 804-312-22MD72-AE-3
	3G	SHO1001-412-20MD54-AE-3	SHO1001-412-34MD66-AE-5	SHO1002-412-18MD60-AD-4	SHO1002-412-26MD66-AD-5	SHO 804-412-28MD72-AE-6
	4W	SHO1001-412-20MD54-AE-4	SHO1002-412-20MD60-AD-4	SHO1002-412-20MD66-AD-5	SHO1002-412-34MD72-AE-2	SHO 804-412-24MD72-AE-6
3	2W	SHO1001-212-18MD54-AE-2	SHO1001-212-28MD60-AE-3	SHO1002-212-18MD60-AD-2	SHO1002-212-22MD66-AD-3	SHO1002-212-22MD72-AD-4
	3W	SHO1001-312-20MD54-AE-3	SHO1001-312-28MD60-AE-4	SHO1002-312-18MD60-AD-3	SHO1002-312-24MD66-AD-5	SHO 804-312-22MD72-AE-4
	3G	SHO1001-412-22MD54-AE-4	SHO1002-412-18MD60-AD-4	SHO1002-412-18MD60-AD-4	SHO1002-412-34MD72-AE-2	SHO 804-412-34MD72-AE-6
	4W	SHO1001-412-30MD60-AE-6	SHO1002-412-18MD60-AD-5	SHO1002-412-26MD66-AE-2	SHO 804-412-18MD66-AE-6	SHO1004-412-18MD72-AD-2
2	2W	SHO1001-212-18MD54-AE-3	SHO1001-212-24MD60-AE-3	SHO1002-212-20MD66-AD-4	SHO1002-212-20MD66-AD-4	SHO 804-212-18MD72-AE-4
	3W	SHO1001-312-20MD54-AE-4	SHO1002-312-18MD60-AD-5	SHO1002-312-26MD66-AE-2	SHO1002-312-32MD72-AE-2	SHO 804-312-20MD72-AE-6
	3G	SHO1001-412-30MD60-AE-6	SHO1002-412-20MD60-AE-2	SHO1002-412-26MD66-AE-2	SHO1003-412-32MD72-AE-2	
	4W	SHO1002-412-18ME60-AE-2	SHO1002-412-20ME66-AE-2	SHO1002-412-30ME72-AE-3		
1	2W	SHO1001-220-26ME60-AE-5	SHO1002-220-20ME60-AE-2	SHO1002-220-20ME66-AD-5	SHO 804-220-20ME72-AE-6	
	3W	SHO1002-320-18ME60-AE-2	SHO1002-320-24ME66-AE-3	SHO1002-320-28ME72-AE-3		
	3G	SHO1002-420-18ME60-AE-3	SHO1002-420-22ME66-AE-3	SHO1003-420-26ME72-AE-2		
	4W	SHO1002-420-20MF60-AE-3	SHO1002-420-22MF66-AE-4	SHO1003-420-22MF72-AE-2		
1/0	2W	SHO1001-220-26ME60-AE-6	SHO1002-220-20ME66-AE-2	SHO1002-220-30ME72-AE-3	SHO1004-220-20ME72-AD-2	
	3W	SHO1002-320-18MF60-AE-3	SHO1002-320-24MF66-AE-4	SHO1003-320-22MF72-AE-2		
	3G	SHO1002-420-18MF60-AE-4	SHO1002-420-24MF66-AE-4	SHO1003-420-22MF72-AE-2		
2/0	2W	SHO1002-220-18MF60-AE-2	SHO1002-220-20MF66-AE-3	SHO1003-220-22MF72-AE-2		
	3W	SHO1002-320-18MF60-AE-4	SHO1002-320-28MF72-AE-5	SHO1003-320-24MF72-AE-3		
	3G	SHO1002-420-18MF60-AE-5	SHO1003-420-18MF66-AE-3	SHO1003-420-24MF72-AE-3		



NOTE: Capacities based on 4 ft. lift to centerline of reel, speed of 150 ft/min., and acceleration of 1.0 ft/sec./sec. Consult factory when these specifications are exceeded or if cable capacity greater than that shown is required.

IMPORTANT NOTICE: These capacities are based on the cable data charts on [page 7](#). For cables of different diameter and weight pr foot, consult factory.

	225 FT.	250 FT.	275 FT.	300 FT.	325 FT.	350 FT.
SHO1002-103-28MC72-AD-3 SHO 803-123-22MD72-AE-4 SHO 803-163-26MC72-AE-5	SHO 803-103-24MC72-AE-3					
SHO1001- 23-26MA54-AC-4 SHO1001- 33-34MA60-AD-2 SHO 802- 43-18MA54-AD-5 SHO 802- 63-30MB66-AE-4 SHO1002- 83-22MC66-AC-5 SHO 803-103-22MD72-AE-4 SHO 804-163-20MD72-AE-3	SHO 802- 23-20MA54-AD-3 SHO 802- 33-18MA54-AD-4 SHO 802- 43-36MA66-AE-3 SHO1002- 63-24MB66-AC-4 SHO 803- 83-28MC72-AE-3	SHO 802- 23-26MA60-AD-5 SHO1002- 33-24MA60-AB-4 SHO1002- 43-22MA60-AC-2 SHO 803- 63-34MB72-AE-3 SHO1003- 83-20MC72-AC-3	SHO 802- 23-26MA60-AD-5 SHO1002- 33-34MA66-AC-3 SHO 803- 43-26MA66-AD-4 SHO 804- 63-28MB72-AD-6	SHO1002- 23-32MA66-AC-2 SHO 803- 33-24MA66-AD-3 SHO 803- 43-26MA66-AD-4 SHO1004- 63-24MB72-AC-2	SHO 803- 23-28MA66-AD-3 SHO 804- 33-26MA66-AD-3 SHO 804- 43-28MA72-AD-3	
SHO1001- 23-32MA60-AD-2 SHO 802- 33-30MA60-AE-3 SHO 802- 43-28MB60-AE-3 SHO1002- 63-24MC66-AC-5 SHO 803- 83-28MC72-AE-5	SHO 802- 23-36MA66-AE-3 SHO 802- 33-36MA66-AE-3 SHO 802- 43-34MB66-AE-3 SHO 803- 63-30MC72-AE-3	SHO1002- 23-22MA60-AB-4 SHO1002- 33-22MA60-AC-2 SHO 803- 43-26MB66-AD-6 SHO1003- 63-22MC72-AC-3	SHO1002- 23-28MA66-AC-2 SHO1002- 33-36MA72-AC-4 SHO 804- 43-18MB66-AD-3	SHO 803- 23-24MA66-AD-3 SHO 804- 33-22MA66-AD-3 SHO 804- 43-30MB72-AD-5	SHO 804- 23-30MA72-AD-3 SHO 804- 33-28MA72-AD-3 SHO 804- 43-30MB72-AD-5	
SHO 802- 27-30MB66-AE-3 SHO1002- 37-26MB66-AC-5 SHO1002- 47-28MB66-AD-2 SHO1002- 47-32MC72-AD-3 SHO 802- 27-26MC66-AE-4 SHO1002- 37-28MC72-AD-3 SHO 803- 47-34MC72-AE-6 SHO 803- 47-30MC72-AE-6 SHO 803-212-28MC72-AE-4 SHO 804-312-22MD72-AE-3 SHO1004-412-22MD72-AD-2	SHO 802- 27-30MB66-AE-3 SHO1002- 37-32MB72-AD-2 SHO 803- 47-32MB72-AE-3 SHO 803- 47-30MC72-AE-4 SHO 803- 27-30MC72-AE-3 SHO 804- 37-26MC72-AE-3 SHO 804- 47-26MC72-AE-3 SHO 804- 47-24MC72-AE-3	SHO1002- 27-36MB72-AC-5 SHO 804- 37-30MB72-AE-2 SHO1004- 47-20MB72-AC-2 SHO1004- 47-18MC72-AC-2 SHO1003- 27-22MC72-AC-3 SHO1004- 37-18MC72-AC-2	SHO 804- 27-24MB72-AD-5 SHO1004- 37-20MB72-AC-2 SHO1004- 47-20MB72-AC-2	SHO 804- 27-24MB72-AD-5		
SHO 804-212-20MD72-AE-3 SHO1004-312-20MD72-AE-2 SHO1004-412-20MD72-AE-2						



SELECTION CHART

SHO SERIES-RANDOM WRAP

WIRE SIZE	COND. NO.	100 FT.	125 FT.	150 FT.	175 FT.	200 FT.
14	10	SHO 801-103-18730-AE-4	SHO1001-103-18730-AC-4	SHO 802-103-16730-AD-4	SHO 802-103-30742-AE-3	SHO 802-103-34454-AE-4
	12	SHO 801-123-18730-AE-6	SHO1001-123-24736-AD-3	SHO 802-123-22442-AE-3	SHO 802-123-36454-AE-6	SHO1002-123-36748-AD-2
	14	SHO1001-143-16730-AD-2	SHO1001-143-36748-AE-3	SHO 802-143-28742-AE-5	SHO1002-143-24742-AC-4	SHO 803-143-36754-AE-3
	16	SHO1001-163-18730-AC-5	SHO1001-163-26442-AD-5	SHO 802-163-24442-AE-4	SHO1002-163-18442-AC-3	SHO1002-163-34454-AD-2
	20	SHO1001-203-18436-AD-4	SHO1001-203-36454-AE-3	SHO1002-203-20736-AC-3	SHO1002-203-34748-AD-3	SHO 803-203-34454-AE-4
	24	SHO1001-243-28742-AE-3	SHO1002-243-16736-AC-4	SHO1002-243-34748-AD-4	SHO 803-243-26454-AE-5	SHO 804-243-34754-AE-3
	30	SHO1001-303-34454-AE-6	SHO1002-303-20742-AD-3	SHO1002-303-26454-AD-5	SHO 804-303-28748-AE-4	SHO1004-303-34754-AD-2
12	2	SHO 801- 23-22430-AD-4	SHO 801- 23-22430-AD-4	SHO 801- 23-22430-AD-4	SHO 801- 23-22430-AD-4	SHO1001- 23-24730-AB-3
	3	SHO 801- 33-22430-AD-5	SHO 801- 33-22430-AD-5	SHO 801- 33-22430-AD-5	SHO 801- 33-22430-AD-5	SHO1001- 33-36442-AC-5
	4	SHO 801- 43-20430-AD-6	SHO 801- 43-20430-AD-6	SHO 801- 43-20430-AD-6	SHO1001- 43-24730-AC-2	SHO 802- 43-18430-AC-4
	6	SHO 801- 63-20430-AE-3	SHO 801- 63-22730-AE-3	SHO 801- 63-26436-AE-4	SHO 802- 63-20730-AD-3	SHO 802- 63-36448-AE-3
	8	SHO 801- 83-18430-AE-3	SHO1001- 83-16430-AC-3	SHO1001- 83-34742-AD-4	SHO 802- 83-34742-AE-3	SHO 802- 83-36448-AE-4
	10	SHO 801-103-18730-AE-6	SHO1001-103-24736-AD-3	SHO 802-103-22442-AE-3	SHO 802-103-36454-AE-6	SHO1002-103-36748-AD-2
	12	SHO1001-123-16730-AD-3	SHO1001-123-36454-AE-3	SHO1002-123-20736-AC-3	SHO1002-123-34748-AD-3	SHO 803-123-32454-AE-3
	14	SHO1001-143-22736-AD-5	SHO1001-143-30454-AE-3	SHO1002-143-16736-AC-3	SHO1002-143-32754-AD-3	SHO 803-143-36754-AE-5
	16	SHO1001-163-18730-AD-3	SHO1001-163-34448-AE-3	SHO1002-163-20763-AC-3	SHO1002-163-34748-AD-3	SHO 803-163-36748-AE-4
	20	SHO1001-203-30742-AE-3	SHO1002-203-18736-AC-4	SHO1002-203-28742-AD-3	SHO 803-203-32754-AE-5	SHO 804-203-34754-AE-3
24	SHO1001-243-30742-AE-4	SHO1002-243-18736-AD-2	SHO1002-243-26454-AD-5	SHO 804-243-30748-AE-4	SHO1003-243-36754-AD-3	
10	2	SHO 801- 23-22430-AD-5	SHO 801- 23-22430-AD-5	SHO 801- 23-22430-AD-5	SHO 801- 23-22430-AD-5	SHO 802- 23-18430-AC-3
	3	SHO 801- 33-20430-AD-6	SHO 801- 33-20430-AD-6	SHO 801- 33-20430-AD-6	SHO1001- 33-18430-AB-3	SHO 802- 33-16430-AC-4
	4	SHO 801- 43-22430-AE-3	SHO 801- 43-28436-AE-3	SHO 801- 43-28436-AE-3	SHO1001- 43-34442-AD-2	SHO 802- 43-18430-AC-6
	6	SHO 801- 63-18430-AE-3	SHO 801- 63-22730-AE-3	SHO1001- 63-28736-AD-2	SHO 802- 63-18730-AD-3	SHO 802- 63-34448-AE-3
	8	SHO 801- 83-20730-AE-6	SHO1001- 83-26736-AD-3	SHO 802- 83-16730-AD-5	SHO 802- 83-36454-AE-6	SHO 803- 83-22736-AD-4
	10	SHO1001-103-16730-AD-3	SHO1001-103-36454-AE-3	SHO1002-103-20736-AC-3	SHO1002-103-34748-AD-3	SHO 803-103-30454-AE-3
	12	SHO1001-123-20736-AD-5	SHO1001-123-34454-AE-4	SHO1002-123-24742-AD-2	SHO1002-123-36754-AD-4	SHO 804-123-34754-AE-3
	14	SHO1001-143-30742-AE-4	SHO1002-143-22742-AD-3	SHO1002-143-32748-AD-5	SHO 804-143-26748-AE-3	SHO 804-143-34754-AE-4
	16	SHO1001-163-30742-AE-3	SHO1002-163-22736-AD-2	SHO1002-163-28742-AD-3	SHO 804-163-34748-AE-3	SHO 804-163-34754-AE-3
	20	SHO1002-203-18736-AD-3	SHO1002-203-24742-AD-4	SHO 804-203-24742-AE-3	SHO 804-203-30748-AE-5	SHO1004-203-36754-AD-2
8	2W	SHO 801- 27-20430-AE-3	SHO 801- 27-22730-AE-3	SHO 801- 27-26436-AE-3	SHO 802- 27-20730-AD-3	SHO 802- 27-20436-AD-3
	3W	SHO 801- 37-18430-AE-3	SHO 801- 37-22730-AE-3	SHO1001- 37-28736-AD-2	SHO 802- 37-20436-AD-5	SHO 802- 37-34448-AE-3
	3G	SHO 801- 47-18430-AE-3	SHO1001- 47-16430-AC-3	SHO 802- 47-20730-AD-4	SHO 802- 47-34742-AE-3	SHO 802- 47-36448-AE-4
	4W	SHO 801- 47-18430-AE-4	SHO1001- 47-16430-AC-4	SHO 802- 47-18730-AD-4	SHO 802- 47-28442-AE-3	SHO 802- 47-36454-AE-4
6	2W	SHO 801- 27-18430-AE-3	SHO 801- 27-22730-AE-3	SHO1001- 27-28736-AD-2	SHO 802- 27-18730-AD-3	SHO 802- 27-34448-AE-3
	3W	SHO 801- 37-14430-AE-4	SHO1001- 37-18730-AC-4	SHO 802- 37-16730-AD-4	SHO 802- 37-32742-AE-3	SHO 802- 37-36454-AE-5
	3G	SHO1001- 47-14430-AC-5	SHO1001- 47-22436-AD-3	SHO 802- 47-26736-AE-3	SHO 802- 47-34454-AE-6	SHO1002- 47-34454-AD-2
	4W	SHO1001- 47-18730-AC-5	SHO1001- 47-26442-AD-5	SHO 802- 47-24442-AE-4	SHO1002- 47-22442-AC-4	SHO1002- 47-36454-AD-3
4	2W	SHO 801-212-20730-AE-6	SHO1001-212-26736-AD-3	SHO 802-212-16730-AD-5	SHO 802-212-36454-AE-6	SHO 803-212-22736-AD-4
	3W	SHO1001-312-18730-AD-3	SHO1001-312-36454-AE-3	SHO1002-312-20736-AC-3	SHO1002-312-32448-AD-3	SHO 803-312-36748-AE-4
	3G	SHO1001-412-20436-AD-5	SHO 802-412-24736-AE-5	SHO1002-412-22442-AD-2	SHO1002-412-36454-AD-4	SHO 804-412-36748-AE-3
	4W	SHO1001-412-26736-AE-2	SHO 802-412-22736-AE-5	SHO1002-412-20736-AC-4	SHO 803-412-34454-AE-6	SHO 804-412-34454-AE-3
3	2W	SHO1001-212-18730-AD-2	SHO1001-212-26442-AD-5	SHO 802-212-22442-AE-3	SHO1002-212-26742-AC-4	SHO 803-212-36748-AE-3
	3W	SHO1001-312-18730-AD-3	SHO1001-312-34454-AE-3	SHO1002-312-18736-AC-3	SHO1002-312-36454-AD-4	SHO 804-312-36748-AE-3
	3G	SHO1001-412-26736-AE-2	SHO 802-412-24736-AE-6	SHO1002-412-30742-AD-3	SHO 803-412-34454-AE-6	SHO 804-412-36748-AE-3
	4W	SHO1001-412-32742-AE-4	SHO1002-412-22736-AD-2	SHO1002-412-34748-AD-5	SHO 804-412-34748-AE-4	SHO 804-412-36754-AE-4
2	2W	SHO1001-212-18436-AD-4	SHO1001-212-36454-AE-3	SHO1002-212-20736-AC-3	SHO1002-212-32454-AD-3	SHO 803-212-34454-AE-4
	3W	SHO1001-312-26736-AE-2	SHO1002-312-18736-AC-4	SHO1002-312-28742-AD-3	SHO 804-312-34748-AE-3	SHO 804-312-34754-AE-3
	3G	SHO1001-412-32742-AE-4	SHO1002-412-22736-AD-2	SHO1002-412-34748-AD-5	SHO 804-412-34748-AE-4	SHO1004-412-36754-AD-2
	4W	SHO1002-412-18736-AD-3	SHO1002-412-28742-AD-4	SHO 804-412-24742-AE-3	SHO 804-412-28748-AE-4	SHO1004-412-34754-AD-2
1	2W	SHO1001-220-28742-AE-3	SHO1002-220-16736-AC-4	SHO1002-220-34748-AD-4	SHO 803-220-34754-AE-6	SHO 804-220-34754-AE-3
	3W	SHO1002-320-18736-AD-3	SHO1002-320-28742-AD-4	SHO 804-320-24742-AE-3	SHO 804-320-30748-AE-5	SHO1004-320-34754-AD-2
	3G	SHO1002-420-18736-AD-3	SHO1002-420-26742-AD-5	SHO 804-420-24742-AE-4	SHO1004-420-30748-AD-2	
	4W	SHO1002-420-20736-AD-4	SHO1002-420-36754-AE-3	SHO1004-420-22742-AD-2		
1/0	2W	SHO1001-220-30742-AE-4	SHO1002-220-18736-AD-2	SHO1002-220-32748-AD-5	SHO 804-220-30748-AE-4	SHO 804-220-36754-AE-5
	3W	SHO1002-320-16736-AD-3	SHO1002-320-26742-AD-5	SHO 804-320-22742-AE-4	SHO1004-320-28748-AD-2	
	3G	SHO1002-420-20736-AD-4	SHO1002-420-36754-AE-3	SHO1004-420-22742-AD-2		
2/0	2W	SHO1002-220-16736-AD-3	SHO1002-220-26742-AD-4	SHO 804-220-22742-AE-3	SHO 804-220-32754-AE-6	
	3W	SHO1002-320-20742-AD-5	SHO1002-320-34754-AE-3	SHO1004-320-22748-AD-2		
	3G	SHO1002-420-24742-AE-2	SHO1003-420-18742-AD-3			



NOTE: Capacities based on 4 ft. lift to centerline of reel, speed of 150 ft/min., and acceleration of 1.0 ft/sec./sec. Consult factory when these specifications are exceeded or if cable capacity greater than that shown is required.

IMPORTANT NOTICE: These capacities are based on the cable data charts on [page 7](#). For cables of different diameter and weight pr foot, consult factory.

	225 FT.	250 FT.	275 FT.	300 FT.	325 FT.	350 FT.
	SHO1002-103-36454-AC-5 SHO 804-123-24742-AD-3 SHO1004-143-28748-AC-2 SHO 803-163-36454-AE-3 SHO 804-203-34454-AE-3	SHO 804-103-28742-AD-3 SHO 804-123-30454-AD-6 SHO1004-143-34754-AC-2 SHO1003-163-30454-AC-3 SHO1004-203-30748-AC-2	SHO 804-103-32454-AD-5 SHO1004-123-30454-AC-2 SHO1004-143-34754-AC-2 SHO1004-163-30454-AC-2			
	SHO 802- 23-20430-AC-3 SHO 802- 33-18430-AC-3 SHO 802- 43-26436-AD-3 SHO1002- 63-26736-AB-3 SHO 803- 83-26442-AD-5 SHO 804-103-24742-AD-3 SHO1003-123-26454-AC-3 SHO1004-143-24748-AC-2 SHO 804-163-34454-AE-3	SHO 802- 23-20430-AC-3 SHO 802- 33-34442-AD-5 SHO1002- 43-22730-AA-2 SHO 803- 63-26442-AD-3 SHO 804- 83-28742-AD-3 SHO 804-103-28454-AD-6 SHO1004-123-26454-AC-2 SHO1004-163-28454-AC-2	SHO 802- 23-32442-AD-3 SHO 803- 33-18430-AB-3 SHO 803- 43-24436-AC-4 SHO 804- 63-24736-AC-4 SHO 804- 83-32448-AD-4 SHO1004-103-30454-AC-2	SHO 803- 23-26436-AC-3 SHO 803- 33-28736-AC-4 SHO 803- 43-36454-AD-3 SHO 804- 63-32448-AD-3 SHO 804- 83-36454-AD-5	SHO 804- 23-20730-AA-4 SHO 804- 33-24436-AB-5 SHO 804- 43-30442-AC-4 SHO 804- 63-36454-AD-3	SHO 804- 23-22436-AB-3 SHO 804- 33-30442-AC-3 SHO1004- 43-30442-AA-2 SHO1004- 63-36454-AB-2
	SHO 802- 23-18430-AC-3 SHO 802- 33-26436-AD-3 SHO 1002- 43-22730-AA-3 SHO 803- 63-26442-AD-4 SHO 803- 83-36454-AE-3 SHO1004-103-26454-AC-2	SHO 802- 23-30736-AD-3 SHO1002- 33-28736-AB-2 SHO 803- 43-24436-AC-5 SHO 804- 63-24736-AC-5 SHO1003- 83-34454-AC-3 SHO1004-103-26454-AC-2	SHO 803- 23-16430-AB-3 SHO 803- 33-28736-AC-5 SHO 803- 43-34742-AD-3 SHO 804- 63-36748-AD-5 SHO1004- 83-36754-AC-2	SHO 803- 23-28736-AC-4 SHO 803- 33-36454-AD-3 SHO 804- 43-26736-AC-3 SHO 804- 63-36454-AD-5	SHO 804- 23-22436-AB-4 SHO 804- 33-28442-AC-4 SHO1004- 43-26442-AA-2	SHO 804- 23-30442-AC-3
	SHO1002- 27-26736-AB-3 SHO1002- 37-34448-AC-4 SHO 803- 47-26442-AD-5 SHO 804- 47-22442-AD-3	SHO 803- 27-26442-AD-3 SHO 804- 37-22736-AC-4 SHO 804- 47-30742-AD-3 SHO 804- 47-28742-AD-3	SHO 803- 27-32742-AD-3 SHO 804- 37-28448-AD-3 SHO 804- 47-36454-AD-5 SHO 804- 47-36454-AD-6	SHO 804- 27-32448-AD-3 SHO 804- 37-36454-AD-4 SHO 804- 47-36454-AD-5	SHO 804- 27-36454-AD-3	SHO1004- 27-36454-AB-2
	SHO1002- 27-34448-AC-4 SHO1002- 37-36454-AC-5 SHO 803- 47-36454-AE-3 SHO 803- 47-36454-AE-3	SHO 804- 27-24736-AC-5 SHO 804- 37-28742-AD-3 SHO1003- 47-32454-AC-3 SHO1004- 47-34748-AC-2	SHO 804- 27-28448-AD-3 SHO1004- 37-32454-AC-2 SHO1004- 47-32454-AC-2 SHO1004- 47-32454-AC-2	SHO 804- 27-36454-AD-4		
	SHO 803-212-36454-AE-3 SHO1004-312-24448-AC-2 SHO 804-412-34454-AE-3	SHO1003-212-32454-AC-3 SHO1004-312-28454-AC-2	SHO1004-212-32454-AC-2			
	SHO 804-212-24742-AD-4 SHO 804-312-34454-AE-3 SHO 804-412-34454-AE-3	SHO1003-212-30454-AC-3	SHO1004-212-30454-AC-2			
	SHO 804-212-34454-AE-3	SHO1004-212-26454-AC-2				



SELECTION CHART

TMR SERIES—MONOSPIRAL WRAP

WIRE SIZE	COND. NO.	100 FT.	125 FT.	150 FT.	175 FT.	200 FT.	
14	10	TMR-103-18MC48-AD-2	TMR-103-22MC54-AD-2	TMR-103-18MC60-AB-2	TMR-103-22MC66-AB-2	TMR-103-22MC66-AB-2	
	12	TMR-123-18MD54-AC-2	TMR-123-20MD60-AC-2	TMR-123-20MD60-AC-2	TMR-123-22MD66-AB-2	TMR-123-26MD72-AB-2	
	14	TMR-143-20MD54-AD-2	TMR-143-20MD60-AC-2	TMR-143-24MD66-AB-2	TMR-143-26MD72-AA-2	TMR-143-20MD72-AC-3	
	16	TMR-163-18MC54-AC-2	TMR-163-18MC54-AC-2	TMR-163-22MC60-AC-2	TMR-163-22MC66-AA-2	TMR-163-26MC72-AA-2	
	20	TMR-203-18MD54-AC-2	TMR-203-20MD60-AB-2	TMR-203-24MD66-AB-2	TMR-203-24MD66-AB-2	TMR-203-26MD72-AA-2	
	24	TMR-243-18ME54-AB-2	TMR-243-24ME66-AA-2	TMR-243-24ME66-AA-2	TMR-243-28ME72-AA-2		
	30	TMR-303-22MF60-AA-2	TMR-303-34MF72-AA-2	TMR-303-28MF72-AC-3	TMR-303-18MF72-AC-5		
12	2	TMR- 23-18MA42-AE-2	TMR- 23-18MA42-AE-2	TMR- 23-18MA48-AE-2	TMR- 23-18MA48-AE-2	TMR- 23-20MA54-AD-2	
	3	TMR- 33-18MA42-AE-2	TMR- 33-18MA42-AE-2	TMR- 33-18MA48-AE-2	TMR- 33-18MA48-AE-2	TMR- 33-18MA54-AD-2	
	4	TMR- 43-18MA42-AE-2	TMR- 43-18MA42-AE-2	TMR- 43-18MA48-AE-2	TMR- 43-18MA54-AD-2	TMR- 43-18MA54-AD-2	
	6	TMR- 63-18MB48-AE-2	TMR- 63-18MB48-AE-2	TMR- 63-18MB54-AD-2	TMR- 63-18MB54-AD-2	TMR- 63-18MB60-AC-2	
	8	TMR- 83-18MC48-AD-2	TMR- 83-18MC54-AD-2	TMR- 83-18MC60-AB-2	TMR- 83-18MC60-AB-2	TMR- 83-22MC66-AB-2	
	10	TMR-103-18MD54-AD-2	TMR-103-20MD60-AC-2	TMR-103-20MD60-AC-2	TMR-103-22MD66-AB-2	TMR-103-24MD72-AA-2	
	12	TMR-123-20MD54-AD-2	TMR-123-20MD60-AC-2	TMR-123-24MD66-AB-2	TMR-123-26MD72-AA-2	TMR-123-20MD72-AC-3	
	14	TMR-143-20ME60-AB-2	TMR-143-20ME60-AB-2	TMR-143-26ME72-AA-2	TMR-143-26ME72-AA-2		
	16	TMR-163-20MD54-AC-2	TMR-163-20MD60-AB-2	TMR-163-24MD66-AB-2	TMR-163-24MD66-AB-2	TMR-163-26MD72-AA-2	
	20	TMR-203-18ME54-AC-2	TMR-203-22ME60-AB-2	TMR-203-24ME66-AA-2	TMR-203-28ME72-AA-2		
24	TMR-243-24ME60-AB-2	TMR-243-26ME66-AA-2	TMR-243-30ME72-AA-2	TMR-243-20ME72-AB-3			
10	2	TMR- 23-18MA42-AE-2	TMR- 23-18MA42-AE-2	TMR- 23-18MA48-AE-2	TMR- 23-18MA48-AE-2	TMR- 23-18MA54-AD-2	
	3	TMR- 33-18MA42-AE-2	TMR- 33-18MA42-AE-2	TMR- 33-18MA48-AE-2	TMR- 33-18MA54-AD-2	TMR- 33-18MA54-AD-2	
	4	TMR- 43-18MB42-AE-2	TMR- 43-18MB48-AE-2	TMR- 43-18MB48-AE-2	TMR- 43-18MB54-AD-2	TMR- 43-18MB54-AD-2	
	6	TMR- 63-18MC48-AE-2	TMR- 63-18MC54-AD-2	TMR- 63-18MC54-AD-2	TMR- 63-18MC60-AB-2	TMR- 63-18MC60-AB-2	
	8	TMR- 83-18MC54-AD-2	TMR- 83-18MC54-AD-2	TMR- 83-20MC60-AC-2	TMR- 83-22MC66-AB-2	TMR- 83-22MC66-AB-2	
	10	TMR-103-20MD54-AD-2	TMR-103-20MD60-AC-2	TMR-103-24MD66-AB-2	TMR-103-26MD72-AA-2	TMR-103-20MD72-AC-3	
	12	TMR-123-20ME60-AB-2	TMR-123-20ME60-AB-2	TMR-123-26ME72-AA-2	TMR-123-26ME72-AA-2		
	14	TMR-143-22MF60-AB-2	TMR-143-18MF66-AA-2	TMR-143-28MF72-AA-2	TMR-143-18MF72-AC-5		
	16	TMR-163-18ME54-AC-2	TMR-163-24ME66-AA-2	TMR-163-24ME66-AA-2	TMR-163-28ME72-AA-2		
20	TMR-203-24ME60-AB-2	TMR-203-26ME66-AA-2	TMR-203-30ME72-AA-2	TMR-203-20ME72-AB-3			
8	2W	TMR- 27-18MB42-AE-2	TMR- 27-18MB48-AE-2	TMR- 27-18MB54-AD-2	TMR- 27-18MB54-AD-2	TMR- 27-18MB60-AC-2	
	3W	TMR- 37-18MB48-AE-2	TMR- 37-18MB54-AD-2	TMR- 37-18MB54-AD-2	TMR- 37-18MB60-AC-2	TMR- 37-18MB60-AC-2	
	3G	TMR- 47-18MB48-AD-2	TMR- 47-18MB54-AD-2	TMR- 47-18MB54-AD-2	TMR- 47-18MB60-AB-2	TMR- 47-18MB60-AB-2	
	4W	TMR- 47-18MC48-AD-2	TMR- 47-18MC54-AD-2	TMR- 47-18MC60-AD-2	TMR- 47-20MC60-AC-2	TMR- 47-22MC66-AB-2	
6	2W	TMR- 27-18MC48-AE-2	TMR- 27-18MC54-AD-2	TMR- 27-18MC54-AD-2	TMR- 27-18MC60-AC-2	TMR- 27-18MC60-AC-2	
	3W	TMR- 37-18MC48-AD-2	TMR- 37-18MC54-AD-2	TMR- 37-18MC54-AD-2	TMR- 37-20MC60-AC-2	TMR- 37-26MC66-AC-2	
	3G	TMR- 47-18MC48-AD-2	TMR- 47-18MC54-AC-2	TMR- 47-18MC54-AC-2	TMR- 47-20MC60-AC-2	TMR- 47-26MC66-AC-2	
	4W	TMR- 47-18MC48-AD-2	TMR- 47-18MC54-AC-2	TMR- 47-20MC60-AC-2	TMR- 47-22MC66-AB-2	TMR- 47-26MC66-AB-2	
4	2W	TMR-212-18MC48-AD-2	TMR-212-18MC54-AD-2	TMR-212-24MC60-AC-2	TMR-212-22MC66-AB-2	TMR-212-22MC66-AB-2	
	3W	TMR-312-18MD54-AC-2	TMR-312-20MD60-AB-2	TMR-312-20MD60-AB-2	TMR-312-22MD66-AA-2	TMR-312-28MD72-AB-2	
	3G	TMR-412-18MD54-AC-2	TMR-412-20MD60-AB-2	TMR-412-20MD60-AB-2	TMR-412-24MD66-AB-2	TMR-412-28MD72-AA-2	
	4W	TMR-412-18MD54-AC-2	TMR-412-20MD60-AB-2	TMR-412-26MD66-AB-2	TMR-412-28MD72-AA-2	TMR-412-24MD72-AC-3	
3	2W	TMR-212-18MD54-AC-2	TMR-212-20MD60-AC-2	TMR-212-20MD60-AC-2	TMR-212-22MD66-AB-2	TMR-212-28MD72-AB-2	
	3W	TMR-312-20MD54-AC-2	TMR-312-20MD60-AB-2	TMR-312-24MD66-AB-2	TMR-312-24MD66-AB-2	TMR-312-26MD72-AA-2	
	3G	TMR-412-20MD54-AC-2	TMR-412-20MD60-AB-2	TMR-412-24MD66-AA-2	TMR-412-24MD66-AA-2	TMR-412-30MD72-AA-2	
	4W	TMR-412-20MD54-AC-2	TMR-412-22MD60-AB-2	TMR-412-24MD66-AA-2	TMR-412-30MD72-AA-2	TMR-412-20MD72-AB-3	
2	2W	TMR-212-18MD54-AC-2	TMR-212-20MD60-AC-2	TMR-212-22MD66-AB-2	TMR-212-26MD72-AA-2	TMR-212-26MD72-AA-2	
	3W	TMR-312-20MD54-AC-2	TMR-312-20MD60-AB-2	TMR-312-24MD66-AB-2	TMR-312-30MD72-AA-2	TMR-312-20MD72-AB-3	
	3G	TMR-412-20MD54-AC-2	TMR-412-22MD60-AB-2	TMR-412-24MD66-AA-2	TMR-412-30MD72-AA-2	TMR-412-20MD72-AB-3	
	4W	TMR-412-22ME60-AB-2	TMR-412-28ME66-AB-2	TMR-412-30ME72-AA-2	TMR-412-22ME72-AB-3		
1	2W	TMR-220-20ME60-AB-2	TMR-220-20ME60-AB-2	TMR-220-26ME72-AA-2	TMR-220-26ME72-AA-2		
	3W	TMR-320-24ME60-AB-2	TMR-320-26ME66-AA-2	TMR-320-30ME72-AA-2	TMR-320-20ME72-AB-3		
	3G	TMR-420-24ME60-AA-2	TMR-420-30ME66-AA-2	TMR-420-24ME72-AB-3	TMR-420-24ME72-AB-3		
	4W	TMR-420-24MF60-AA-2	TMR-420-20MF66-AB-3	TMR-420-22MF72-AB-3			
1/0	2W	TMR-220-20ME60-AB-2	TMR-220-24ME66-AA-2	TMR-220-30ME72-AA-2	TMR-220-20ME72-AB-3		
	3W	TMR-320-26MF66-AA-2	TMR-320-20MF66-AC-3	TMR-320-22MF72-AB-3			
	3G	TMR-420-18MF60-AC-3	TMR-420-20MF66-AB-3	TMR-420-22MF72-AB-3			
2/0	2W	TMR-220-24MF66-AA-2	TMR-220-24MF66-AA-2	TMR-220-22MF72-AB-3			
	3W	TMR-320-18MF60-AC-3	TMR-320-24MF72-AB-3	TMR-320-24MF72-AB-3			
	3G	TMR-420-18MF60-AB-3	TMR-420-24MF72-AB-3	TMR-420-24MF72-AB-3			



NOTE: Capacities based on 4 ft. lift to centerline of reel, speed of 150 ft/min., and acceleration of 1.0 ft/sec./sec. Consult factory when these specifications are exceeded or if cable capacity greater than that shown is required.

IMPORTANT NOTICE: These capacities are based on the cable data charts on [page 7](#). For cables of different diameter and weight pr foot, consult factory.

	225 FT.	250 FT.	275 FT.	300 FT.	325 FT.	350 FT.
TMR-103-24MC72-AA-2 TMR-123-22MD72-AC-3	TMR-103-24MC72-AA-2					
TMR-163-26MC72-AA-2	TMR-163-20MC72-AC-3					
TMR- 23-20MA54-AD-2 TMR- 33-18MA54-AD-2 TMR- 43-18MA54-AD-2 TMR- 63-22MB66-AB-2 TMR- 83-22MC66-AB-2 TMR-103-20MD72-AC-3	TMR- 23-20MA54-AD-2 TMR- 33-18MA54-AD-2 TMR- 43-18MA60-AC-2 TMR- 63-22MB66-AB-2 TMR- 83-24MC72-AA-2	TMR- 23-18MA60-AC-2 TMR- 33-18MA60-AC-2 TMR- 43-18MA60-AC-2 TMR- 63-24MB72-AB-2 TMR- 83-20MC72-AC-3	TMR- 23-18MA60-AC-2 TMR- 33-18MA60-AC-2 TMR- 43-20MA66-AB-2 TMR- 63-24MB72-AB-2	TMR- 23-18MA60-AC-2 TMR- 33-20MA66-AB-2 TMR- 43-20MA66-AB-2 TMR- 63-24MB72-AB-2	TMR- 23-20MA66-AB-2 TMR- 33-20MA66-AB-2 TMR- 43-20MA66-AB-2	TMR- 23-20MA66-AB-2 TMR- 33-20MA66-AB-2 TMR- 43-20MA66-AB-2
TMR-163-20MD72-AB-3						
TMR- 23-18MA54-AD-2 TMR- 33-18MA60-AC-2 TMR- 43-18MB60-AC-2 TMR- 63-22MC66-AB-2 TMR- 83-28MC72-AB-2	TMR- 23-20MA60-AD-2 TMR- 33-18MA60-AC-2 TMR- 43-18MB60-AC-2 TMR- 63-24MC72-AA-2 TMR- 83-20MC72-AC-3	TMR- 23-20MA60-AD-2 TMR- 33-18MA60-AC-2 TMR- 43-22MB66-AC-2 TMR- 63-24MC72-AA-2	TMR- 23-20MA60-AD-2 TMR- 33-20MA66-AB-2 TMR- 43-22MB66-AC-2 TMR- 63-18MC72-AD-5	TMR- 23-20MA66-AB-2 TMR- 33-20MA66-AB-2 TMR- 43-24MB72-AB-2	TMR- 23-20MA66-AB-2 TMR- 33-20MA66-AB-2 TMR- 43-24MB72-AB-2	TMR- 23-20MA66-AB-2 TMR- 33-20MA66-AB-2 TMR- 43-24MB72-AB-2
TMR- 27-18MB60-AC-2 TMR- 37-22MB66-AB-2 TMR- 47-22MB66-AB-2 TMR- 47-22MC66-AB-2	TMR- 27-20MB66-AB-2 TMR- 37-22MB66-AB-2 TMR- 47-22MB66-AB-2 TMR- 47-24MC72-AA-2	TMR- 27-20MB66-AB-2 TMR- 37-24MB72-AA-2 TMR- 47-24MB72-AA-2 TMR- 47-24MC72-AA-2	TMR- 27-24MB72-AB-2 TMR- 37-20MB72-AC-3 TMR- 47-20MB72-AC-3	TMR- 27-24MB72-AB-2	TMR- 27-20MB72-AC-3	
TMR- 27-22MC66-AB-2 TMR- 37-24MC72-AA-2 TMR- 47-26MC72-AB-2 TMR- 47-26MC72-AB-2	TMR- 27-24MC72-AA-2 TMR- 37-24MC72-AA-2 TMR- 47-26MC72-AB-2 TMR- 47-24MC72-AC-3	TMR- 27-24MC72-AA-2 TMR- 37-18MC72-AD-5 TMR- 47-18MC72-AD-5	TMR- 27-18MC72-AD-5			
TMR-212-24MC72-AA-2 TMR-312-20MD72-AB-3 TMR-412-20MD72-AB-3	TMR-212-24MC72-AA-2					
TMR-212-20MD72-AC-3 TMR-312-20MD72-AB-3 TMR-412-20MD72-AB-3						



SELECTION CHART

TMR SERIES—RANDOM WRAP

WIRE SIZE	COND. NO.	100 FT.	125 FT.	150 FT.	175 FT.	200 FT.	
14	10	TMR-103-16730-AE-2	TMR-103-16730-AE-2	TMR-103-16730-AE-2	TMR-103-14736-AE-2	TMR-103-14736-AE-2	
	12	TMR-123-14730-AE-2	TMR-123-14730-AE-2	TMR-123-16736-AE-2	TMR-123-16736-AE-2	TMR-123-16736-AE-2	
	14	TMR-43-216730-AE-2	TMR-143-14736-AD-2	TMR-143-14736-AD-2	TMR-143-14736-AD-2	TMR-143-14736-AD-2	
	16	TMR-163-14730-AE-2	TMR-163-14730-AE-2	TMR-163-14730-AE-2	TMR-163-14736-AD-2	TMR-163-14736-AD-2	
	20	TMR-203-14730-AE-2	TMR-203-14730-AE-2	TMR-203-14736-AD-2	TMR-203-14736-AD-2	TMR-203-14736-AD-2	
	24	TMR-243-16736-AD-2	TMR-243-16736-AD-2	TMR-243-16742-AC-2	TMR-243-16742-AC-2	TMR-243-16742-AC-2	
12	30	TMR-303-14736-AC-2	TMR-303-14736-AC-2	TMR-303-20742-AC-2	TMR-303-20742-AC-2	TMR-303-22748-AB-2	
	2	TMR- 23-14430-AE-2	TMR- 23-14430-AE-2	TMR- 23-14430-AE-2	TMR- 23-14430-AE-2	TMR- 23-14430-AE-2	
	3	TMR- 33-14430-AE-2	TMR- 33-14430-AE-2	TMR- 33-14430-AE-2	TMR- 33-14430-AE-2	TMR- 33-14430-AE-2	
	4	TMR- 43-14430-AE-2	TMR- 43-14430-AE-2	TMR- 43-14430-AE-2	TMR- 43-14430-AE-2	TMR- 43-14430-AE-2	
	6	TMR- 63-14430-AE-2	TMR- 63-14430-AE-2	TMR- 63-14430-AE-2	TMR- 63-14730-AE-2	TMR- 63-14730-AE-2	
	8	TMR- 83-14430-AE-2	TMR- 83-14430-AE-2	TMR- 83-14730-AE-2	TMR- 83-14730-AE-2	TMR- 83-14730-AE-2	
	10	TMR-103-14730-AE-2	TMR-103-14730-AE-2	TMR-103-16736-AE-2	TMR-103-16736-AE-2	TMR-103-16736-AE-2	
	12	TMR-123-14730-AE-2	TMR-123-14730-AE-2	TMR-123-14736-AD-2	TMR-123-14736-AD-2	TMR-123-14736-AD-2	
	14	TMR-143-16736-AD-2	TMR-143-16736-AD-2	TMR-143-16736-AD-2	TMR-143-18742-AD-2	TMR-143-18742-AD-2	
	16	TMR-163-14730-AE-2	TMR-163-14730-AE-2	TMR-163-14736-AD-2	TMR-163-14736-AD-2	TMR-163-14736-AD-2	
10	20	TMR-203-16730-AE-2	TMR-203-14736-AD-2	TMR-203-14736-AD-2	TMR-203-18742-AC-2	TMR-203-18742-AC-2	
	24	TMR-243-14736-AD-2	TMR-243-14736-AD-2	TMR-243-20742-AC-2	TMR-243-20742-AC-2	TMR-243-22748-AB-2	
	2	TMR- 23-14430-AE-2	TMR- 23-14430-AE-2	TMR- 23-14430-AE-2	TMR- 23-14430-AE-2	TMR- 23-14430-AE-2	
	3	TMR- 33-14430-AE-2	TMR- 33-14430-AE-2	TMR- 33-14430-AE-2	TMR- 33-14430-AE-2	TMR- 33-14430-AE-2	
	4	TMR- 43-14430-AE-2	TMR- 43-14430-AE-2	TMR- 43-14430-AE-2	TMR- 43-14430-AE-2	TMR- 43-14430-AE-2	
	6	TMR- 63-14430-AE-2	TMR- 63-14430-AE-2	TMR- 63-14730-AE-2	TMR- 63-14730-AE-2	TMR- 63-14730-AE-2	
	8	TMR- 83-16730-AE-2	TMR- 83-16730-AE-2	TMR- 83-16730-AE-2	TMR- 83-14736-AE-2	TMR- 83-14736-AE-2	
	10	TMR-103-14730-AE-2	TMR-103-14730-AE-2	TMR-103-14736-AD-2	TMR-103-14736-AD-2	TMR-103-14736-AD-2	
	12	TMR-123-16736-AD-2	TMR-123-16736-AD-2	TMR-123-16736-AD-2	TMR-123-18742-AD-2	TMR-123-18742-AD-2	
	14	TMR-143-14736-AD-2	TMR-143-14736-AD-2	TMR-143-16742-AC-2	TMR-143-16742-AC-2	TMR-143-22748-AC-2	
8	16	TMR-163-16730-AE-2	TMR-163-14736-AD-2	TMR-163-14736-AD-2	TMR-163-18742-AC-2	TMR-163-18742-AC-2	
	20	TMR-203-14736-AD-2	TMR-203-14736-AD-2	TMR-203-20742-AC-2	TMR-203-20742-AC-2	TMR-203-22748-AB-2	
	2W	TMR- 27-14430-AE-2	TMR- 27-14430-AE-2	TMR- 27-14430-AE-2	TMR- 27-14730-AE-2	TMR- 27-14730-AE-2	
	3W	TMR- 37-14430-AE-2	TMR- 37-14430-AE-2	TMR- 37-14730-AE-2	TMR- 37-14730-AE-2	TMR- 37-14730-AE-2	
6	3G	TMR- 47-14430-AE-2	TMR- 47-14430-AE-2	TMR- 47-14730-AE-2	TMR- 47-14730-AE-2	TMR- 47-14730-AE-2	
	4W	TMR- 47-14430-AE-2	TMR- 47-14430-AE-2	TMR- 47-14730-AE-2	TMR- 47-14730-AE-2	TMR- 47-14730-AE-2	
	2W	TMR- 27-14430-AE-2	TMR- 27-14430-AE-2	TMR- 27-14730-AE-2	TMR- 27-14730-AE-2	TMR- 27-14730-AE-2	
	3W	TMR- 37-14430-AE-2	TMR- 37-14730-AE-2	TMR- 37-14730-AE-2	TMR- 37-14730-AE-2	TMR- 37-14736-AE-2	
4	3G	TMR- 47-14430-AE-2	TMR- 47-14730-AE-2	TMR- 47-14730-AE-2	TMR- 47-14730-AE-2	TMR- 47-14736-AE-2	
	4W	TMR- 47-16730-AE-2	TMR- 47-16730-AE-2	TMR- 47-16730-AE-2	TMR- 47-14736-AE-2	TMR- 47-14736-AE-2	
	2W	TMR-212-14730-AE-2	TMR-212-14730-AE-2	TMR-212-14730-AE-2	TMR-212-14730-AE-2	TMR-212-14736-AE-2	
	3W	TMR-312-14730-AE-2	TMR-312-14730-AE-2	TMR-312-14736-AD-2	TMR-312-14736-AD-2	TMR-312-14736-AD-2	
3	3G	TMR-412-14730-AE-2	TMR-412-14730-AE-2	TMR-412-14736-AD-2	TMR-412-14736-AD-2	TMR-412-14736-AD-2	
	4W	TMR-412-14730-AE-2	TMR-412-14730-AE-2	TMR-412-14736-AD-2	TMR-412-14736-AD-2	TMR-412-14736-AD-2	
	2W	TMR-212-14730-AE-2	TMR-212-14730-AE-2	TMR-212-14736-AE-2	TMR-212-14736-AE-2	TMR-212-14736-AE-2	
	3W	TMR-312-14730-AE-2	TMR-312-14730-AE-2	TMR-312-14736-AD-2	TMR-312-14736-AD-2	TMR-312-14736-AD-2	
2	3G	TMR-412-14730-AE-2	TMR-412-14730-AE-2	TMR-412-14736-AD-2	TMR-412-14736-AD-2	TMR-412-14736-AD-2	
	4W	TMR-412-14736-AD-2	TMR-412-14736-AD-2	TMR-412-18742-AC-2	TMR-412-18742-AC-2	TMR-412-18742-AC-2	
	2W	TMR-212-14730-AE-2	TMR-212-14730-AE-2	TMR-212-14736-AE-2	TMR-212-14736-AE-2	TMR-212-14736-AE-2	
	3W	TMR-312-16730-AE-2	TMR-312-14736-AD-2	TMR-312-14736-AD-2	TMR-312-14736-AD-2	TMR-312-14736-AD-2	
1	3G	TMR-412-16730-AD-2	TMR-412-14736-AD-2	TMR-412-14736-AD-2	TMR-412-14736-AD-2	TMR-412-14736-AD-2	
	4W	TMR-420-16736-AC-2	TMR-420-22742-AB-2	TMR-420-22742-AB-2	TMR-420-28748-AB-2	TMR-420-24748-BA-2	
	2W	TMR-220-16736-AD-2	TMR-220-16736-AD-2	TMR-220-16736-AD-2	TMR-220-18742-AD-2	TMR-220-18742-AD-2	
	3W	TMR-320-14736-AD-2	TMR-320-14736-AD-2	TMR-320-20742-AC-2	TMR-320-20742-AC-2	TMR-320-22748-AB-2	
1/0	3G	TMR-420-16736-AC-2	TMR-420-22742-AB-2	TMR-420-22742-AB-2	TMR-420-28748-AB-2	TMR-420-24748-BA-2	
	2W	TMR-220-14736-AD-2	TMR-220-14736-AD-2	TMR-220-16742-AC-2	TMR-220-16742-AC-2	TMR-220-20748-AB-2	
	3W	TMR-320-16736-AC-2	TMR-320-18742-AC-2	TMR-320-18742-AC-2	TMR-320-24748-BB-2	TMR-320-24748-BB-2	
2/0	3G	TMR-420-16736-AC-2	TMR-420-22742-AB-2	TMR-420-22742-AB-2	TMR-420-28748-AB-2	TMR-420-24748-BA-2	
	2W	TMR-220-16736-AD-2	TMR-220-18742-AC-2	TMR-220-18742-AC-2	TMR-220-20748-AB-2	TMR-220-20748-AB-2	
	3W	TMR-320-18742-AB-2	TMR-320-18742-AB-2	TMR-320-18742-AB-2	TMR-320-24748-BA-2	TMR-320-24748-BA-2	
	3G	TMR-420-24742-AB-2	TMR-420-30748-AA-2	TMR-420-28754-BA-2	TMR-420-28754-BA-2	TMR-420-28754-BA-2	



NOTE: Capacities based on 4 ft. lift to centerline of reel, speed of 150 ft/min., and acceleration of 1.0 ft/sec./sec. Consult factory when these specifications are exceeded or if cable capacity greater than that shown is required.

IMPORTANT NOTICE: These capacities are based on the cable data charts on [page 7](#). For cables of different diameter and weight pr foot, consult factory.

	225 FT.	250 FT.	275 FT.	300 FT.	325 FT.	350 FT.
TMR-103-14736-AE-2	TMR-103-14736-AE-2	TMR-103-14736-AE-2	TMR-103-14736-AE-2	TMR-103-18742-AD-2	TMR-103-18742-AD-2	TMR-103-18742-AD-3
TMR-123-14742-AC-2	TMR-123-14742-AC-2	TMR-123-14742-AC-2	TMR-123-14742-AC-2	TMR-123-14742-AC-2	TMR-123-14742-AC-2	TMR-123-20748-AC-2
TMR-143-16742-AD-2	TMR-143-16742-AD-2	TMR-143-16742-AD-2	TMR-143-16742-AD-2	TMR-143-18748-AB-2	TMR-143-18748-AB-2	TMR-143-18754-AC-2
TMR-163-14736-AD-2	TMR-163-14736-AD-2	TMR-163-14736-AD-2	TMR-163-14736-AD-2	TMR-163-16742-AD-2	TMR-163-16742-AD-2	TMR-163-16742-AD-2
TMR-203-18742-AD-2	TMR-203-18742-AD-2	TMR-203-18742-AD-2	TMR-203-18742-AD-2	TMR-203-20748-AB-2	TMR-203-20748-AB-2	TMR-203-20748-AB-2
TMR-243-22748-AB-2	TMR-243-22748-AB-2	TMR-243-22748-AB-2	TMR-243-20754-AC-2	TMR-243-20754-AC-2	TMR-243-20754-AC-2	TMR-243-20754-AC-2
TMR-303-22748-AB-2	TMR-303-20754-BB-2	TMR-303-20754-BB-2	TMR-303-20754-BB-2	TMR-303-20754-BB-2		
TMR- 23-14430-AE-2	TMR- 23-14430-AE-2	TMR- 23-14430-AE-2	TMR- 23-14430-AE-2	TMR- 23-14430-AE-2	TMR- 23-14430-AE-2	TMR- 23-14730-AE-2
TMR- 33-14430-AE-2	TMR- 33-14430-AE-2	TMR- 33-14430-AE-2	TMR- 33-14430-AE-2	TMR- 33-14430-AE-2	TMR- 33-14730-AE-2	TMR- 33-14730-AE-2
TMR- 43-14430-AE-2	TMR- 43-14430-AE-2	TMR- 43-14430-AE-2	TMR- 43-14430-AE-2	TMR- 43-14430-AE-2	TMR- 43-14730-AE-2	TMR- 43-14730-AE-2
TMR- 63-14730-AE-2	TMR- 63-14730-AE-2	TMR- 63-14730-AE-2	TMR- 63-14730-AE-2	TMR- 63-14736-AE-2	TMR- 63-14736-AE-2	TMR- 63-14736-AE-2
TMR- 83-16436-AE-2	TMR- 83-14736-AE-2	TMR- 83-14736-AE-2	TMR- 83-14736-AE-2	TMR- 83-14736-AE-2	TMR- 83-14736-AE-2	TMR- 83-14736-AE-2
TMR-103-14742-AC-2	TMR-103-14742-AC-2	TMR-103-14742-AC-2	TMR-103-14742-AC-2	TMR-103-14742-AC-2	TMR-103-14742-AC-2	TMR-103-20748-AC-2
TMR-123-16742-AD-2	TMR-123-16742-AD-2	TMR-123-16742-AD-2	TMR-123-18748-AB-2	TMR-123-18748-AB-2	TMR-123-18748-AB-2	TMR-123-18754-BC-2
TMR-143-20748-AC-2	TMR-143-20748-AC-2	TMR-143-20754-AC-2	TMR-143-20754-AC-2	TMR-143-20754-AC-2	TMR-143-20754-AC-2	TMR-143-20754-AC-2
TMR-163-18742-AD-2	TMR-163-18742-AD-2	TMR-163-18742-AD-2	TMR-163-18742-AD-2	TMR-163-20748-AB-2	TMR-163-20748-AB-2	TMR-163-20748-AC-2
TMR-203-18742-AC-2	TMR-203-20748-AB-2	TMR-203-20748-AB-2	TMR-203-20748-AB-2	TMR-203-20748-AB-2	TMR-203-18754-BB-2	TMR-203-18754-BB-2
TMR-243-22748-AB-2	TMR-243-22754-BC-2	TMR-243-22754-BC-2	TMR-243-22754-BC-2	TMR-243-22754-AC-2	TMR-243-22754-BC-2	
TMR- 23-14430-AE-2	TMR- 23-14430-AE-2	TMR- 23-14430-AE-2	TMR- 23-14430-AE-2	TMR- 23-14430-AE-2	TMR- 23-14730-AE-2	TMR- 23-14730-AE-2
TMR- 33-14430-AE-2	TMR- 33-14430-AE-2	TMR- 33-14730-AE-2	TMR- 33-14730-AE-2	TMR- 33-14730-AE-2	TMR- 33-14730-AE-2	TMR- 33-14730-AE-2
TMR- 43-14430-AE-2	TMR- 43-14730-AE-2	TMR- 43-14730-AE-2	TMR- 43-14730-AE-2	TMR- 43-14730-AE-2	TMR- 43-14730-AE-2	TMR- 43-14730-AE-2
TMR- 63-14730-AE-2	TMR- 63-14730-AE-2	TMR- 63-14736-AE-2	TMR- 63-14736-AE-2	TMR- 63-14736-AE-2	TMR- 63-14736-AE-2	TMR- 63-14736-AE-2
TMR- 83-14736-AE-2	TMR- 83-14736-AE-2	TMR- 83-14736-AE-2	TMR- 83-14736-AE-2	TMR- 83-18742-AD-2	TMR- 83-18742-AD-2	TMR- 83-18742-AD-2
TMR-103-16742-AD-2	TMR-103-16742-AD-2	TMR-103-18748-AB-2	TMR-103-18748-AB-2	TMR-103-18748-AB-2	TMR-103-18748-AB-2	TMR-103-18754-BC-2
TMR-123-20748-AC-2	TMR-123-20748-AC-2	TMR-123-20754-BC-2	TMR-123-20754-BC-2	TMR-123-20754-BC-2	TMR-123-20754-BC-2	TMR-123-20754-BC-2
TMR-143-22748-AC-2	TMR-143-20754-BC-2	TMR-143-20754-BC-2	TMR-143-20754-BC-2	TMR-143-20754-BC-2		
TMR-163-18742-AC-2	TMR-163-14748-AC-2	TMR-163-24748-AC-2	TMR-163-24748-AC-2	TMR-163-24748-AC-2	TMR-163-18754-BC-2	TMR-163-18754-BC-2
TMR-203-22748-AB-2	TMR-203-22754-BC-2	TMR-203-22754-BC-2	TMR-203-22754-BC-2	TMR-203-22754-BC-2	TMR-203-22754-BC-2	
TMR- 27-14730-AE-2	TMR- 27-14730-AE-2	TMR- 27-14730-AE-2	TMR- 27-14730-AE-2	TMR- 27-14736-AE-2	TMR- 27-14736-AE-2	TMR- 27-14736-AE-2
TMR- 37-14730-AE-2	TMR- 37-14730-AE-2	TMR- 37-18736-AE-2	TMR- 37-18736-AE-2	TMR- 37-18736-AE-2	TMR- 37-18736-AE-2	TMR- 37-18736-AE-2
TMR- 47-14730-AE-2	TMR- 47-14730-AE-2	TMR- 47-18736-AE-2	TMR- 47-18736-AE-2	TMR- 47-18736-AE-2	TMR- 47-18736-AE-2	TMR- 47-18736-AE-2
TMR- 47-16736-AE-2	TMR- 47-16736-AE-2	TMR- 47-16736-AE-2	TMR- 47-16736-AE-2	TMR- 47-16736-AE-2	TMR- 47-16736-AE-2	TMR- 47-14742-AC-2
TMR- 27-14730-AE-2	TMR- 27-14730-AE-2	TMR- 27-14736-AE-2	TMR- 27-14736-AE-2	TMR- 27-14736-AE-2	TMR- 27-14736-AE-2	TMR- 27-14736-AE-2
TMR- 37-14736-AE-2	TMR- 37-14736-AE-2	TMR- 37-14736-AE-2	TMR- 37-14736-AE-2	TMR- 37-14736-AE-2	TMR- 37-14742-AD-2	TMR- 37-14742-AD-2
TMR- 47-14736-AE-2	TMR- 47-14736-AE-2	TMR- 47-14736-AE-2	TMR- 47-14736-AE-2	TMR- 47-14736-AE-2	TMR- 47-14742-AC-2	TMR- 47-14742-AC-2
TMR- 47-14736-AE-2	TMR- 47-14736-AE-2	TMR- 47-14736-AE-2	TMR- 47-14736-AE-2	TMR- 47-18742-AD-2	TMR- 47-18742-AD-2	TMR- 47-18742-AD-2
TMR-212-14736-AE-2	TMR-212-14736-AE-2	TMR-212-14736-AE-2	TMR-212-14736-AE-2	TMR-212-16742-AD-2	TMR-212-16742-AD-2	TMR-212-16742-AD-2
TMR-312-14736-AD-2	TMR-312-16742-AD-2	TMR-312-16742-AD-2	TMR-312-16742-AD-2	TMR-312-16742-AD-2	TMR-312-22748-AA-2	TMR-312-22748-AA-2
TMR-412-14736-AD-2	TMR-412-16742-AC-2	TMR-412-16742-AC-2	TMR-412-16742-AC-2	TMR-412-16742-AC-2	TMR-412-20454-AC-2	TMR-412-20454-AC-2
TMR-412-18742-AC-2	TMR-412-18742-AC-2	TMR-412-18742-AC-2	TMR-412-18742-AC-2	TMR-412-20454-AC-2	TMR-412-20454-AC-2	TMR-412-20748-BB-2
TMR-212-14736-AE-2	TMR-212-14742-AC-2	TMR-212-14742-AC-2	TMR-212-14742-AC-2	TMR-212-14742-AC-2	TMR-212-14742-AC-2	TMR-212-18748-AC-2
TMR-312-18742-AD-2	TMR-312-18742-AD-2	TMR-312-18742-AD-2	TMR-312-18742-AD-2	TMR-312-20748-AC-2	TMR-312-20748-AC-2	TMR-312-20748-AC-2
TMR-412-18742-AC-2	TMR-412-18742-AC-2	TMR-412-18742-AC-2	TMR-412-18742-AC-2	TMR-412-18454-AC-2	TMR-412-18454-AC-2	TMR-412-20748-BB-2
TMR-412-16742-AC-2	TMR-412-16742-AC-2	TMR-412-16742-AC-2	TMR-412-16742-AC-2	TMR-412-22748-BB-2	TMR-412-22748-BB-2	TMR-412-18754-BB-2
TMR-212-14742-AC-2	TMR-212-14742-AC-2	TMR-212-14742-AC-2	TMR-212-14742-AC-2	TMR-212-18748-AB-2	TMR-212-18748-AB-2	TMR-212-18748-AB-2
TMR-312-16742-AC-2	TMR-312-16742-AC-2	TMR-312-16742-AC-2	TMR-312-16742-AC-2	TMR-312-22748-BC-2	TMR-312-22748-BC-2	TMR-312-18754-BC-2
TMR-412-16742-AC-2	TMR-412-16742-AC-2	TMR-412-16742-AC-2	TMR-412-16742-AC-2	TMR-412-22748-BB-2	TMR-412-22748-BB-2	TMR-412-20754-BC-2
TMR-412-24748-BB-2	TMR-412-20754-BC-2	TMR-412-20754-BC-2	TMR-412-20754-BC-2	TMR-412-20754-BC-2	TMR-412-20754-BC-2	TMR-412-20754-BC-2
TMR-220-20748-AB-2	TMR-220-20748-AB-2	TMR-220-18754-BC-2	TMR-220-18754-BC-2	TMR-220-18754-BC-2	TMR-220-18754-BC-2	TMR-220-18754-BC-2
TMR-320-22748-AB-2	TMR-320-22754-BC-2	TMR-320-22754-BC-2	TMR-320-22754-BC-2	TMR-320-22754-BC-2	TMR-320-22754-BC-2	
TMR-420-22748-BA-2	TMR-420-22754-BB-2	TMR-420-22754-BB-2	TMR-420-22754-BB-2	TMR-420-22754-BB-2	TMR-420-22754-BB-2	
TMR-420-22754-BB-2	TMR-420-22754-BB-2	TMR-420-22754-BB-2	TMR-420-22754-BB-2	TMR-420-18754-BD-3		
TMR-220-20748-AB-2	TMR-220-20748-AB-2	TMR-220-18754-BC-2	TMR-220-18754-BC-2	TMR-220-18754-BC-2	TMR-220-18754-BC-2	
TMR-320-20754-BB-2	TMR-320-20754-BB-2	TMR-320-20754-BB-2	TMR-320-20754-BB-2	TMR-320-20754-BB-2		
TMR-420-22754-BB-2	TMR-420-22754-BB-2	TMR-420-22754-BB-2	TMR-420-22754-BB-2			
TMR-220-20748-AB-2	TMR-220-20754-BC-2	TMR-220-20754-BC-2	TMR-220-20754-BC-2	TMR-220-20754-BC-2		
TMR-320-26754-BA-2	TMR-320-26754-BA-2	TMR-320-20754-BC-3				
TMR-420-28754-BA-2						

STEP 7

DIMENSION DRAWINGS – SHO SERIES - MONOSPIRAL WRAP

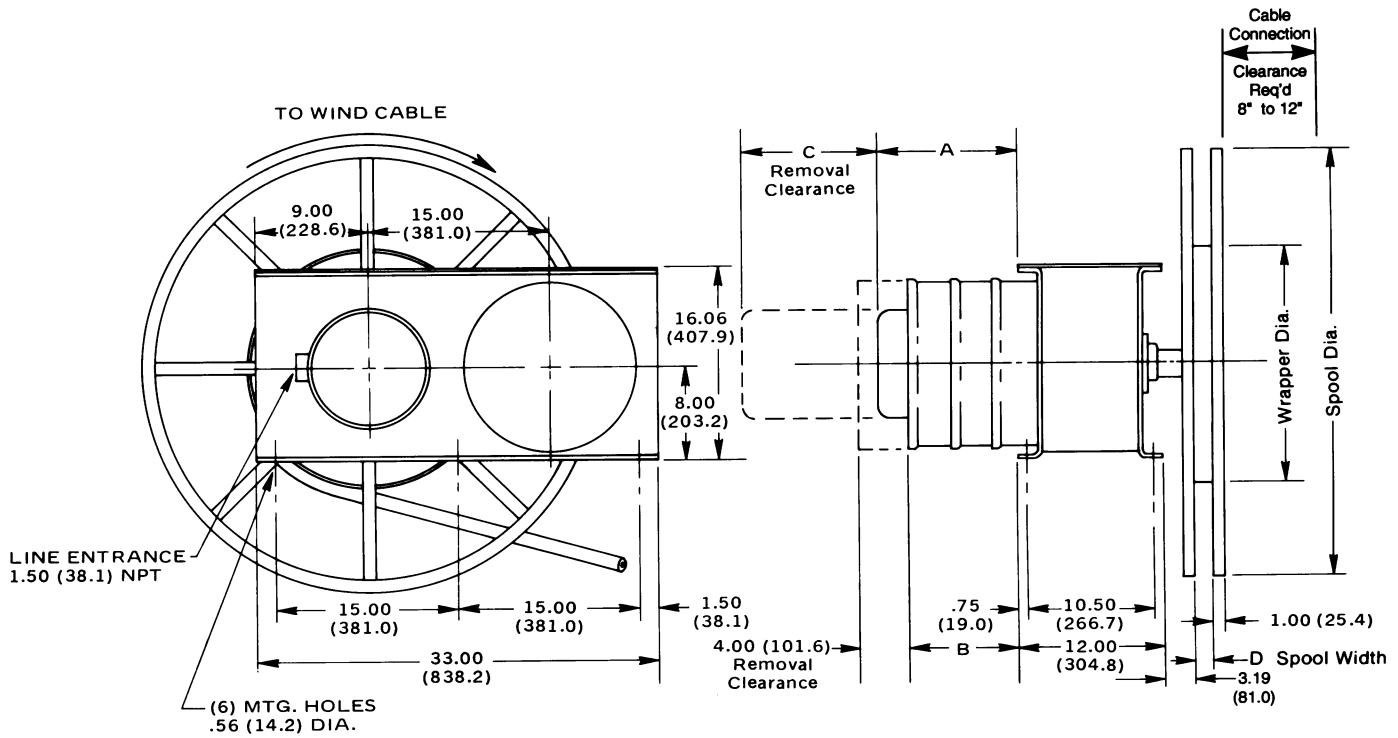

Slip Ring Housing Dimensions

		23	63	103	143	203	303
		33	83	123	163	243	363
		43	27	312	412		
			37				
			47				
			212				
			220				
			320				
			420				
"A" Dimension	inches (mm)	10.69 (272)	13.19 (335)	15.69 (399)	18.19 (462)	23.19 (589)	30.19 (767)
"C" Dimension	inches (mm)	8.50 (216)	11.00 (279)	13.50 (343)	16.00 (406)	21.00 (533)	29.00 (737)

"D" Dimension Monospiral Widths		
Code	Width	
	in	(mm)
MA	0.75	(19)
MB	1.00	(25)
MC	1.25	(32)
MD	1.50	(38)
ME	1.75	(44)
MF	2.00	(51)

Motor Dimensions

		801	802	803	804	1001	1002	1003	1004
"B" Dimension	inches (mm)	1.19 (30)	3.56 (90)	5.94 (151)	8.31 (211)	2.19 (56)	5.56 (141)	8.94 (227)	12.31 (313)
Approximate Net Weight	lbs. (kg)	485 (220)	530 (240)	580 (263)	625 (284)	595 (270)	655 (297)	715 (324)	775 (352)

DIMENSION DRAWINGS – SHO SERIES - RANDOM WRAP

STEP 7

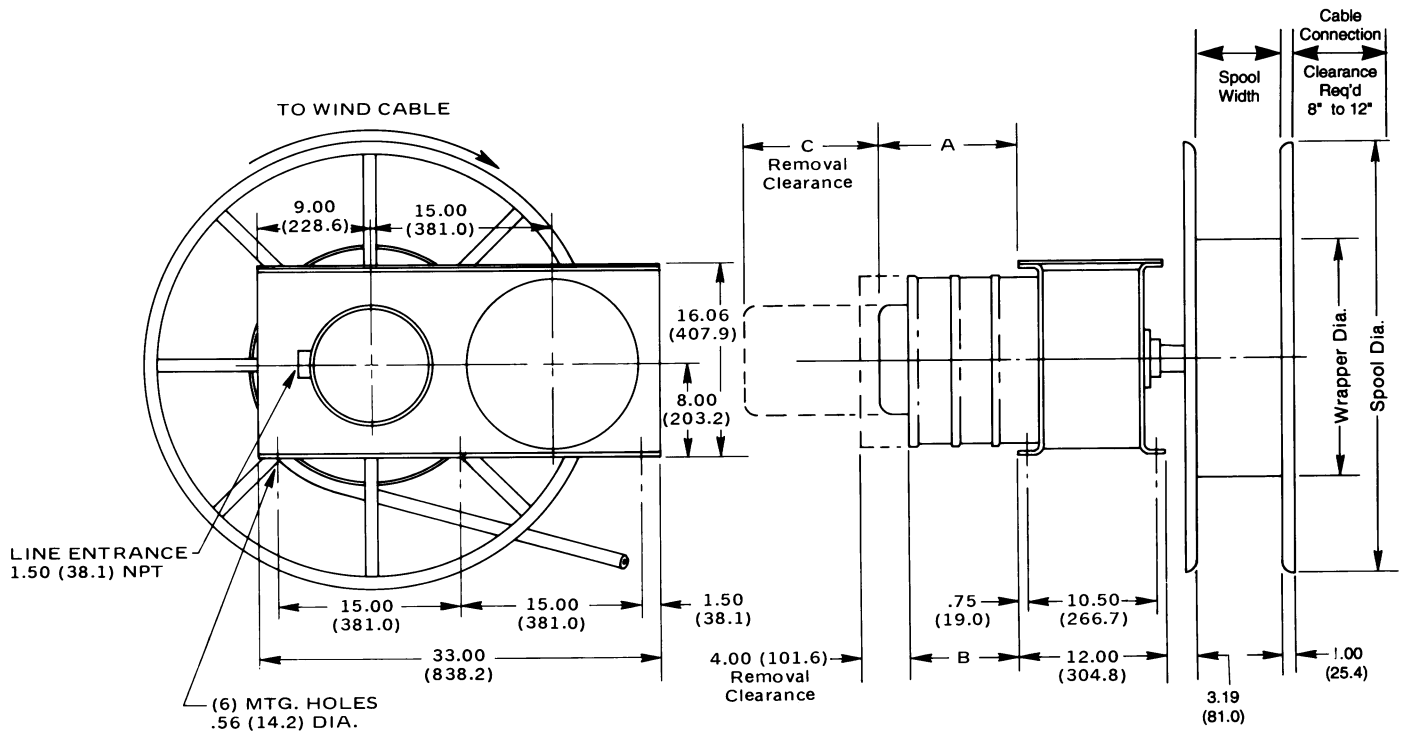

Slip Ring Housing Dimensions

Second Series of Digits in Model Number		23	63	103	143	203	303
		33	83	123	163	243	363
		43	27	312	412		
			37				
			47				
			212				
			220				
		320					
		420					
"A" Dimension	inches (mm)	10.69 (272)	13.19 (335)	15.69 (399)	18.19 (462)	23.19 (589)	30.19 (767)
"C" Dimension	inches (mm)	8.50 (216)	11.00 (279)	13.50 (343)	16.00 (406)	21.00 (533)	29.00 (737)

Motor Dimensions

Last Series of Digits in Model Number		801	802	803	804	1001	1002	1003	1004
"B" Dimension	inches (mm)	1.19 (30)	3.56 (90)	5.94 (151)	8.31 (211)	2.19 (56)	5.56 (141)	8.94 (227)	12.31 (313)
Approximate Net Weight	lbs. (kg)	485 (220)	530 (240)	580 (263)	625 (284)	595 (270)	655 (297)	715 (324)	775 (352)

STEP 7

DIMENSION DRAWINGS – TMR SERIES - MONOSPIRAL WRAP

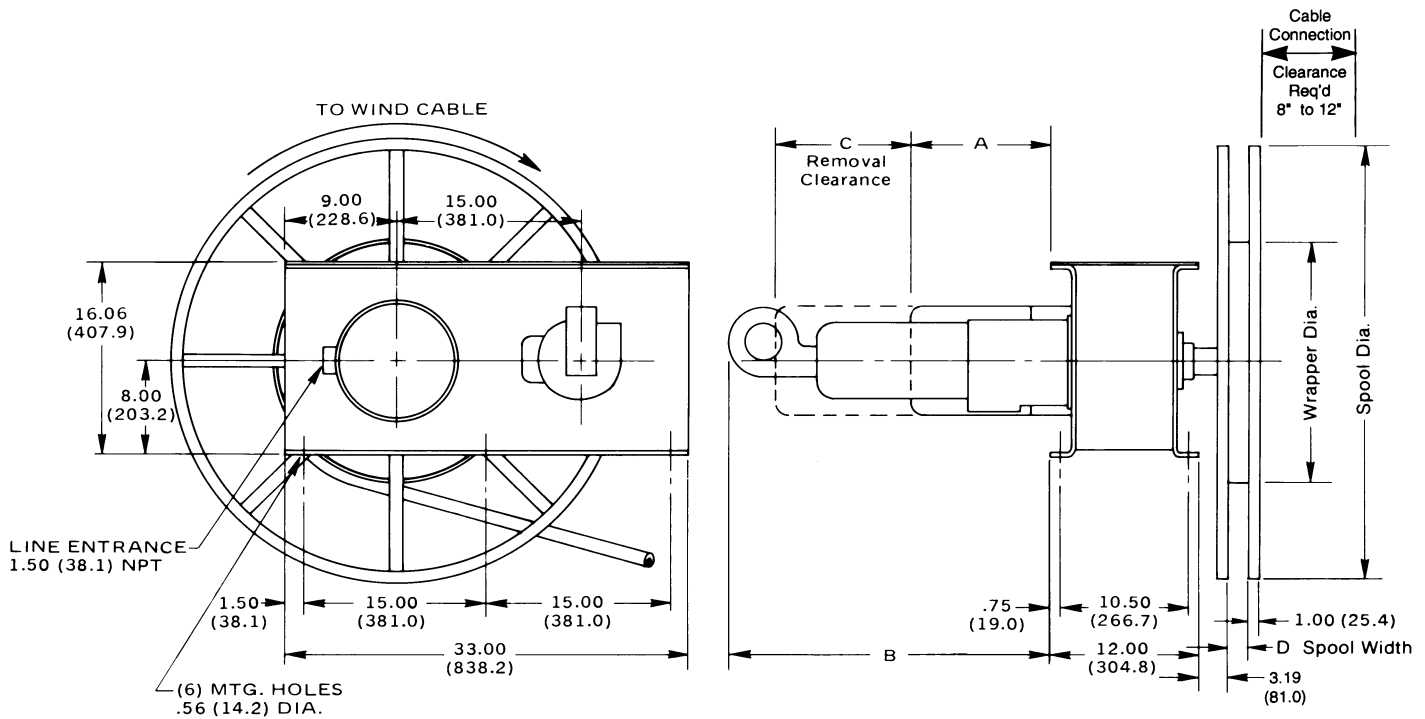

Slip Ring Housing Dimensions

Second Series of Digits in Model Number	Dimensions						
	23	63	103	143	203	303	
	33	83	123	163	243	363	
	43	27	312	412			
		37					
		47					
		212					
		220					
		320					
		420					
"A" Dimension	inches (mm)	10.69 (272)	13.19 (335)	15.69 (399)	18.19 (462)	23.19 (589)	30.19 (767)
"C" Dimension	inches (mm)	8.50 (216)	11.00 (279)	13.50 (343)	16.00 (406)	21.00 (533)	29.00 (737)

"D" Dimension Monospiral Widths		
Code	Width	
	in	(mm)
MA	0.75	(19)
MB	1.00	(25)
MC	1.25	(32)
MD	1.50	(38)
ME	1.75	(44)
MF	2.00	(51)

Motor Dimensions

Last Series of Digits in Model Number		2	3	5	8	10	14
"B" Dimension	inches (mm)	26.55 (674)	27.75 (705)	30.54 (776)	34.98 (888)	37.11 (943)	39.79 (1011)
Approximate Net Weight	lbs. (kg)	585 (265)	600 (272)	615 (279)	630 (286)	645 (293)	660 (299)

DIMENSION DRAWINGS – TMR SERIES - RANDOM WRAP

STEP 7

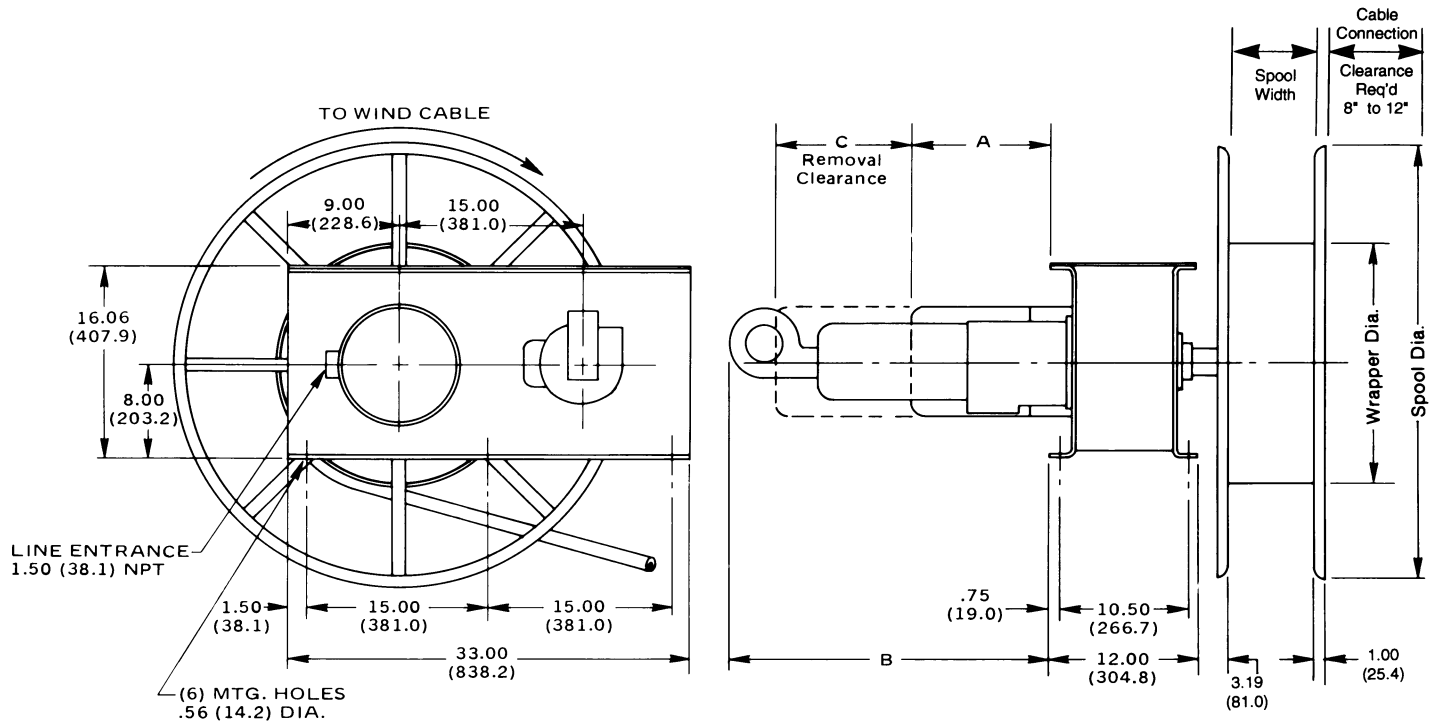

Slip Ring Housing Dimensions

Second Series of Digits in Model Number	Model Numbers						
	23	63	103	143	203	303	
	33	83	123	163	243	363	
	43	27	312	412			
		37					
		47					
		212					
		220					
		320					
		420					
"A" Dimension	inches	10.69	13.19	15.69	18.19	23.19	30.19
	(mm)	(272)	(335)	(399)	(462)	(589)	(767)
"C" Dimension	inches	8.50	11.00	13.50	16.00	21.00	29.00
	(mm)	(216)	(279)	(343)	(406)	(533)	(737)

Motor Dimensions

Last Series of Digits in Model Number		2	3	5	8	10	14
"B" Dimension	inches	26.55	27.75	30.54	34.98	37.11	39.79
	(mm)	(674)	(705)	(776)	(888)	(943)	(1011)
Approximate Net Weight	lbs.	585	600	615	630	645	660
	(kg)	(265)	(272)	(279)	(286)	(293)	(299)

STEP 8

SPECIAL APPLICATION REQUIREMENTS

REEL FOR HAZARDOUS LOCATIONS

Gleason SHO Series Reels are available with enclosures suitable for Explosion-proof, Class I, Group C and D (Gaseous Atmospheres) and Dust Ignition-proof, Class II, Group E, F and G (Dust Atmospheres). Consult factory for further details.

CORROSIVE AND SALT AIR ATMOSPHERES

Gleason SHO Reels are available with epoxy coating and stainless hardware for protection against these atmospheres. Consult factory for recommendations.

NON-CATALOGED APPLICATIONS

The Gleason SHO and TMR Model Selection charts are based on a horizontal retrieve application, 4 ft. lift to centerline of reel, speed of 150 ft./min., acceleration of 1.0 ft./sec./sec., and the cable data charts on [page 7](#). Consult factory when these specifications are exceeded; if additional cable capacity is required, for cables of different diameters and weight per foot from the chart, or if an application other than horizontal retrieve, such as horizontal stretch or vertical lift, is appropriate.

HORIZONTAL STRETCH APPLICATIONS

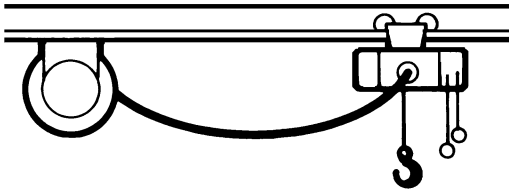

MONORAIL HOISTS - CRANES - TRANSFER CARS - COAL CARS - PAPER MACHINERY

Stretching cable horizontally requires the greatest amount of tension of any application to maintain a minimum sag.

VERTICAL LIFT APPLICATIONS

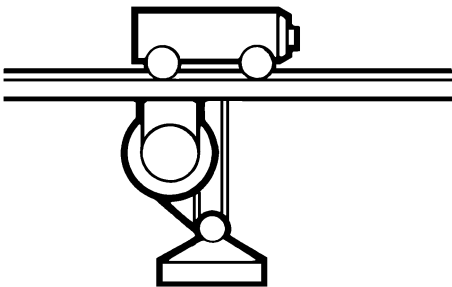

MAGNETS - ROTATING HOOKS - ELECTRIC BUCKETS-ELEVATORS-PENDANT STATIONS - WINDOW WASHING EQUIPMENT - STACKER CRANES

Any application where cable is simply hoisted vertically with only the weight of the cable involved. Special consideration must be given to any weight added to the end of the cable such as a pushbutton station.

WE HANDLE HOSE!

Gleason "SHO" and "TMR" reels can be designed to meet your hose handling needs in long retrieve applications. Consult the factory for a recommendation and information on our complete line of INDUSTRIAL HOSE REELS.

Gleason SHO/TMR Series Reel Eight Step Summary

STEP 1 DESIGN FEATURES	Compare features of SHO/TMR Series to insure proper selection.	PAGES 3 - 5
STEP 2 SPOOLING CONFIGURATION	Determine spool configuration – Random or Monospiral Wrap.	PAGE 6
STEP 3 CABLE SELECTION	Make an informed cable selection based on factors outlined here.	PAGES 6 - 7
STEP 4 REEL MODEL SELECTION	Decide on reel model and learn significance of its number designation.	PAGE 8
STEP 5 CABLE CONNECTION REQUIREMENTS	Calculate cable connection requirement.	PAGE 8
STEP 6 HOW TO ORDER	Instructions and examples on ordering.	PAGE 9
STEP 7 DIMENSION DRAWINGS	Detailed Dimensions and Profiles of SHO/TMR Reels.	PAGES 18 - 21
STEP 8 SPECIAL APPLICATIONS	Special applications for SHO/TMR Series Reels.	PAGE 22



Cable Management

Since 1911 Gleason Reel Corp. has been in the business of CABLE MANAGEMENT. Our products are designed to convey and protect valuable cables and hoses that power and control moving machines of all types. They improve productivity and safety on the job by moving cables and hoses away from hazardous locations on machinery or the shop floor into a controlled environment. Whether you choose Reels for efficient storage and payout from virtually any angle, Festoon Systems for overhead applications or PowerTrak® for protection on machinery in motion, your cables and/or hoses will last longer and provide better service with a cable management system from **Gleason Reel Corp. ...**

...The Cable & Hose Management Company.

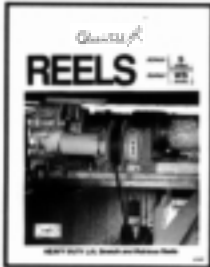

Bulletin "CR"
Heavy Duty
Spring Driven
Electric Cable Reels

General Industrial

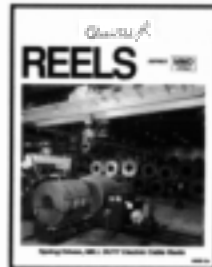

Bulletin "MMD"
Mill Duty
Spring Driven
Electric Cable Reels

Demanding Service

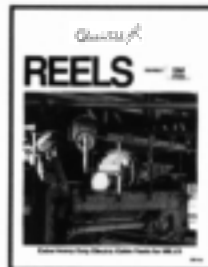

Bulletin "SM"
Heavy Mill Duty
Spring Driven
Electric Cable Reels

Steel Mill Service



Bulletin "RET"
Long Travel Length
Spring/Motor Driven
Electric Cable Reels

Standard Industrial

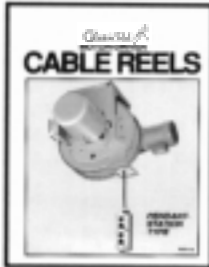

Bulletin "PSR"
Lifting & Lowering
Motor Driven
Electric Cable Reels

Push-Button Reels

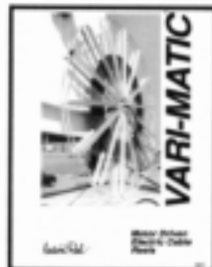

Bulletin "VMR"
Large Retrieving
Motor Driven
Electric Cable Reels

Heavy Duty Industrial

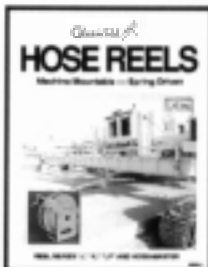

Bulletin "HRM"
Various Types
Spring-Driven
Hose Reels

General Industrial



Bulletin "SR"
Slip Rings
Unitized Design
Low & High Amperage

Low & Medium Voltage



Bulletin "PTG"
Non-metallic
Cable Chain
For Hose & Cable

Lightweight, Economical

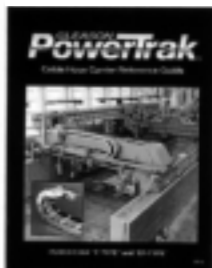

Bulletin "PT"
Rugged Steel
Cable Chain
For Cables & Hoses

Standard & Mill Duty

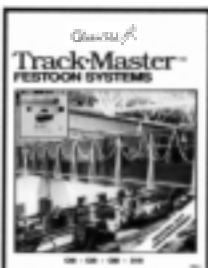

Bulletin "FC"
Flat & Round Cable
C-Rail Mounted
Festoon Systems

General Industrial



Bulletin "FB"
Heavy Duty
I-Beam Mounted
Festoon Systems

Heavy Duty Port Types

In your area contact:



HUBBELL A Hubbell Company

Gleason Reel Corp.

P.O. Box 26 • 600 S. Clark St.

Mayville, WI 53050

Phone 920-387-4120 • Fax 920-387-4189

Printed in U.S.A.

BULLETIN NO. RET-3c

©Copyright GLEASON REEL CORP., 1998

PRINTED 11/98 5M