

# M91-2-T1

12/24 VDC, 12 pnp/npn digital inputs, 2 high-speed counter/shaft encoder inputs, 12 transistor outputs, I/O expansion port, RS232/RS485 port

<b>Power supply</b>	
Permissible range	12VDC or 24VDC
Maximum current consumption	10.2VDC to 28.8VDC with less than 10% ripple 80mA@24VDC (pnp inputs) 140mA@12VDC (pnp inputs) 170mA (npn inputs)
<b>Digital inputs</b>	
Nominal input voltage	12VDC or 24VDC. See Notes 2 and 3.
Input voltages for pnp (source):	
For 12VDC	0-3VDC for Logic '0' 8-15.6VDC for Logic '1'
For 24VDC	0-5VDC for Logic '0' 17-28.8VDC for Logic '1'
Input voltages for npn (sink):	
For 12VDC	8-15.6VDC/<1.2mA for Logic '0' 0-3VDC/>3mA for Logic '1'
For 24VDC	17-28.8VDC/<2mA for Logic '0' 0-5VDC/>6mA for Logic '1'
Input current	4mA@12VDC 8mA@24VDC
Input impedance	3KΩ
Response time (except high-speed inputs)	10mS typical
Galvanic isolation	None
Input cable length	Up to 100 meters, unshielded
<b>High-speed counter</b>	
	Specifications below apply when inputs are wired for use as a high-speed counter input/shaft encoder. See Notes 4 and 5.
Resolution	16-bit
Input freq.	10kHz max.
Minimum pulse	40μs

**Notes:**

- All 12 inputs can be set to pnp (source) or npn (sink) via a single jumper and appropriate wiring.
- All 12 inputs can function in 12 VDC or 24 VDC; set via a single jumper and appropriate wiring.
- npn (sink) inputs use voltage supplied from the controller's power supply.
- Inputs #0 and #2 can each function as either high-speed counter or as part of a shaft encoder. In each case, high-speed input specifications apply. When used as a normal digital input, normal input specifications apply.
- Inputs #1 and #3 can each function as either counter reset, or as a normal digital input; in either case, specifications are those of a normal digital input. These inputs may also be used as part of a shaft encoder. In this case, high-speed input specifications apply.



**Warnings:**

- Unused pins should not be connected. Ignoring this directive may damage the controller.
- Improper use of this product may severely damage the controller.
- Refer to the controller's User Guide regarding wiring considerations.
- Before using this product, it is the responsibility of the user to read the product's User Guide and all accompanying documentation.

**Power supply, pnp (source) inputs**

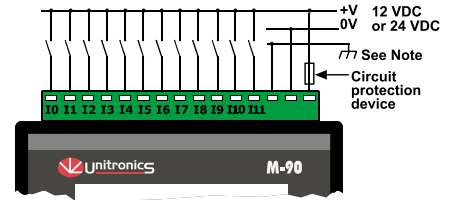

Note:  
To avoid electromagnetic interference, mount the controller in a metal panel/cabinet and earth the power supply. Earth the power supply signal to the metal using a wire whose length does not exceed 10cm. If your conditions do not permit this, do not earth the power supply.

**npn (sink) inputs**

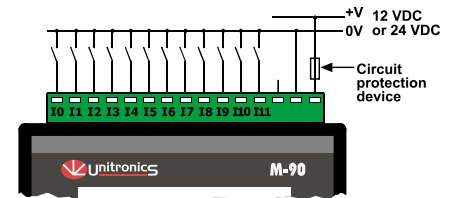

**pnp (source) high-speed counter**

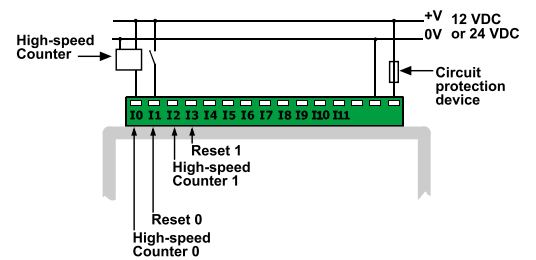

**npn (sink) high-speed counter**

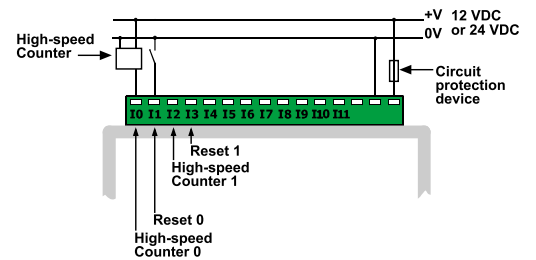

**Shaft encoder**

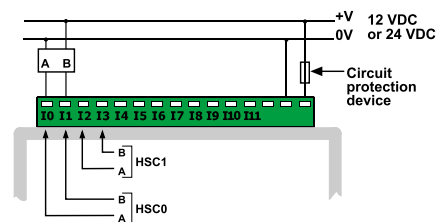

<b>Digital outputs</b>	12 pnp (source) outputs 12VDC or 24VDC
Output type	P-MOSFET (open drain)
Isolation	None
Output current	0.5A max. Total current: 3A max.
Max. frequency for normal outputs	50Hz (resistive load) 0.5Hz (inductive load)
High speed output maximum frequency	2kHz (resistive load) See Note 1.
Short circuit protection	Yes
Short indication	by software
On voltage drop	0.5VDC maximum
<b>Power supply for outputs</b>	
Operating voltage	10.2 to 28.8VDC
Nominal operating voltage	12VDC or 24VDC

Note:

- Output #0 and Output #1 may be used as high-speed outputs.

### Outputs connection

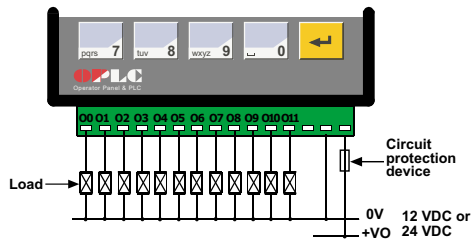

<b>Display</b>	STN, LCD display
Illumination	LED yellow-green backlight
Display size	2 lines, 16 characters long
Character size	5 x 8 matrix, 2.95 x 5.55mm
<b>Keypad</b>	Sealed membrane
Number of keys	15

<b>PLC program</b>	
Ladder Code Memory (virtual)	36K
Memory Bits (coils)	256
Memory Integers (Registers)	256
Timers	64
Execution time	12µsec. for bit operations
Database	1024 integers (indirect access)
HMI displays	80 user-designed displays
HMI variables	64 HMI variables are available to conditionally display and modify text, numbers, dates, times & timer values. The user can also create a list of up to 120 variable text displays, totaling up to 2K.

<b>RS232/RS485 serial port</b>	Used for: <ul style="list-style-type: none"> <li>• Application Download/Upload</li> <li>• Application Testing (Debug)</li> <li>• Connect to GSM or standard telephone modem: <ul style="list-style-type: none"> <li>- Send/receive SMS messages</li> <li>- Remote access programming</li> </ul> </li> <li>• RS485 Networking</li> </ul>
<b>RS232</b> (see note)	1 port
Galvanic isolation	None
Voltage limits	±20V
<b>RS485</b> (see note)	1 port
Input voltage	-7 to +12V differential max.
Cable type	Shielded twisted pair, in compliance with EIA RS485
Galvanic isolation	None
Baud rate	110 – 57600 bps
Nodes	Up to 32

Note:

RS232/RS485 is determined by jumper settings and wiring as described in the document "M91 RS485 Port Settings" packaged with the controller.

<b>I/O expansion port</b>	Up to 64 additional I/Os, including digital & analog I/Os, RTD and more.
<b>Miscellaneous</b>	
Clock (RTC)	Real-time clock functions (Date and Time).
Battery back-up	7 years typical battery back-up for RTC and system data.
Weight	266g (9.37 oz.)
Operational temperature	0 to 50°C (32 to 122°F)
Storage temperature	-20 to 60°C (-4 to 140°F)
Relative Humidity (RH)	5% to 95% (non-condensing)
Mounting method	DIN-rail mounted (IP20/NEMA1) Panel mounted (IP65/NEMA4X)

The tables below show how to set a specific jumper to change the functionality of the inputs. To open the controller and access the jumpers, refer to the directions at the end of these specifications.

**Important:**

Incompatible jumper settings and wiring connections may severely damage the controller.

**JP8**

**Input type (for all digital inputs)**

To use as	JP8
npn (sink)	A
pnp (source)*	B

**JP9**

**Input voltage (for all digital inputs)**

To use as	JP9
12VDC	A
24VDC*	B

\*Default factory setting

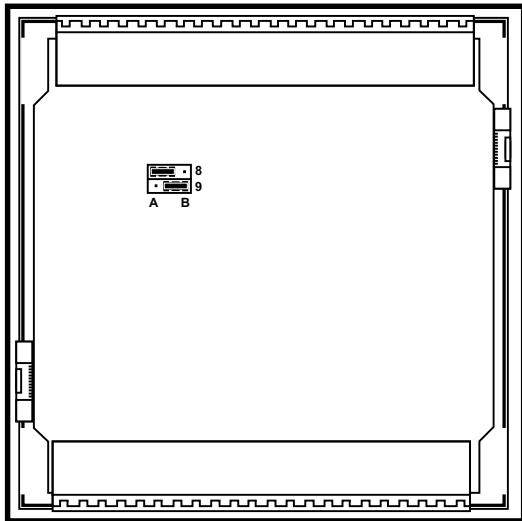

In this figure, the jumper settings will cause the inputs to function as npn, 24VDC digital inputs

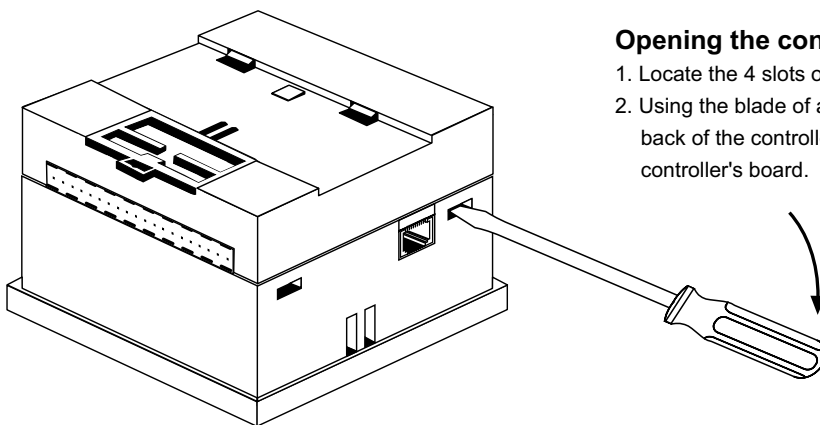

**Opening the controller enclosure**

1. Locate the 4 slots on the sides of the enclosure
2. Using the blade of a flat-bladed screwdriver, gently pry off the back of the controller as shown in the figure below, exposing the controller's board.

Unitronics reserves the right to revise this publication from time to time and to amend its contents and related hardware and software at any time.

Technical updates (if any) may be included in subsequent editions (if any).

Unitronics product sold hereunder can be used with certain products of other manufacturers at the user's sole responsibility.