

INSTALLATION AND OPERATING INSTRUCTIONS

KBPC-225

SCR SPEED AND TORQUE CONTROL

NEMA 4X, IP-65

DESIGNED FOR SHUNT WOUND & PM DC MOTORS

RATED 3 HP @ 180 VDC

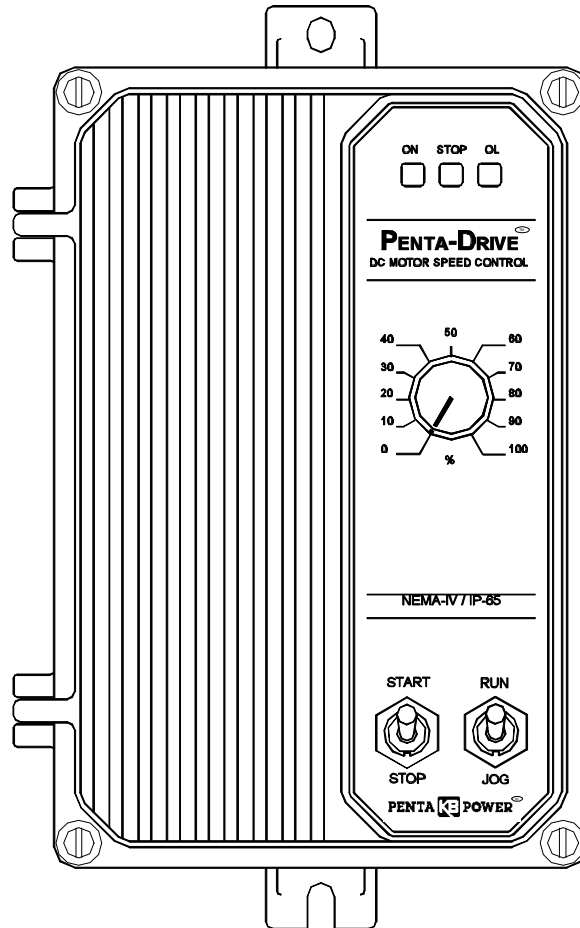

CE
See Page 3



See Safety Warning on Page 3

The information contained in this manual is intended to be accurate. However, the manufacturer retains the right to make changes in design which may not be included herein.
(Shown with optional Run-Stop-Jog Switch)

PENTA KE POWER™

A COMPLETE LINE OF MOTOR DRIVES

© 1998 KB Electronics, Inc.

TABLE OF CONTENTS

<u>Section</u>	<u>Page</u>
i. Safety Warning	3
ii. Simplified Operating Instructions	3
I. General Information	3
II. Setting Speed or Torque Mode of Drive (Jumper J1)	6
III. Setting Selectable Jumpers	6
IV. Mounting	7
V. Wiring	8
VI. Fusing	10
VII. Operation	11
VIII. Trimpot Adjustments	11
IX. Function Indicator Lamps	12
X. Optional Accessories	13
XI. Limited Warranty	20

TABLES

1. Electrical Ratings	4
2. General Performance Specifications	4
3. Field Connections (Shunt Wound Motors Only)	8
4. Parts List	16

FIGURES

1. Control Layout	5
2a. Motor Speed vs. Potentiometer Rotation	6
2b. Preset Motor Speed vs. Motor Load	6
3a. Motor Output Torque vs. Potentiometer Rotation	6
3b. Motor Speed vs. Applied Motor Load	6
4a. Captive Screw Tightened In Case	8
4b. Captive Screw Engaged In Front Cover	8
5. Connection Diagram	8
6a. Full Voltage Field	9
6b. Half Voltage Field	9
7. Tachometer Connection Diagram	9
8a. Remote Potentiometer Connection	10
8b. Analog Voltage Connection	10
9. Remote Start/Stop Switch Connection	10
10a. Inhibit Circuit Wiring	10
10b. Enable Circuit Wiring	10
11. Mechanical Specifications	14
12. Schematic	15
13. Internal Connection Diagram	17
14. Connection Diagrams KBPC-225 With KBSI-240D (Signal Isolator)	18



i. SAFETY WARNING! — PLEASE READ CAREFULLY

This product should be installed and serviced by a qualified technician, electrician or electrical maintenance person familiar with its operation and the hazards involved. Proper installation, which includes wiring, mounting in proper enclosure, fusing or other overcurrent protection and grounding, can reduce the chance of electric shocks, fires or explosion in this product or products used with this product, such as electric motors, switches, coils, solenoids and/or relays. Eye protection must be worn and insulated adjustment tools must be used when working with control under power. This product is constructed of materials (plastics, metals, carbon, silicon, etc.) which may be a potential hazard. Proper shielding, grounding and filtering of this product can reduce the emission of radio frequency interference (RFI) which may adversely affect sensitive electronic equipment. If information is required on this product, contact our factory. It is the responsibility of the equipment manufacturer and individual installer to supply this safety warning to the ultimate user of this product. (SW effective 11/92)

This control contains electronic Start/Stop and Inhibit circuits that can be used to start and stop the control. However, these circuits are never to be used as safety disconnects since they are not fail-safe. Use only the AC line for this purpose.

The input circuits of this control (potentiometer, start/stop, Inhibit) are not isolated from AC line. Be sure to follow all instructions carefully. Fire and/or electrocution can result due to improper use of this product.



This product complies with all CE directives pertinent at the time of manufacture. Contact factory for detailed installation instructions and Declaration of Conformity. Installation of a CE approved RFI filter (KBRF-200, KB P/N 9945 or equivalent) is required. Additional shielded motor cable and/or AC line cables may be required along with a signal isolator (KBSI-240D, KB P/N 9431 or equivalent).

ii. KBPC-225 SIMPLIFIED OPERATING INSTRUCTIONS

IMPORTANT – You must read these simplified operating instructions before you proceed. These instructions are to be used as a reference only and are not intended to replace the detailed instructions provided herein. You must read the Safety Warning before proceeding.

1. Connections.

- A. AC Line. Wire AC line voltage (230 VAC - 50/60 Hz) to terminals L1 and L2. Connect ground wire (earth) to Green Screw on case.
- B. Motor.
 - a. Permanent Magnet (PM) Type: Connect motor armature leads to terminals A1(+) and A2(-).
 - b. Shunt Wound Motors: Connect motor armature as above. Connect full voltage shunt field wires (180 volt motors with 200 volt fields) to F1 and F2. Connect half voltage field wires (180 volt motors with 100 volt fields) to F1 and L1.

2. Speed or Torque Mode – Jumper J1 is factory set for speed control operation ("SPD"). For torque control, set J1 to "TRQ" position.

3. Trimpot Settings – All trimpots have been factory set in accordance with Fig. 1 and Table 2.

4. Diagnostic LEDs – After power is turned on, observe LEDs to verify proper control function.

5. Fusing – Install 25 amp - 250 VAC fuses in both the AC Line and armature leads. See Section VI (p. 10, 11).

I. GENERAL INFORMATION.

The KBPC Series Nema 4 X (IP-65) is a unidirectional SCR DC Motor Speed and Torque Control designed for applications requiring watertight integrity, including washdown. Its housing is ruggedly constructed of die cast aluminum, protected with an acrylic coating that provides excellent corrosion resistance. All switches are sealed with rubber boots and the main speed potentiometer contains a shaft seal.

The electronics for the KBPC is state-of-the-art and includes short circuit and transient protection which provides the ultimate in reliability. Electronic overload protection prevents motor burnout and demagnetization of PM motors. The control can be operated in either the Speed or Torque mode via jumper selection.

Standard features include electronic start/stop and an LED indicator array for Power On, Stop and Overload.

Although the KBPC is factory set for most applications, a variety of trimpots allow adjustment of the following parameters: Minimum and Maximum Speed, Acceleration, Deceleration, Current Limit, IR Comp, and Timed Current Limit. Optional features offered are: Run-Stop-Jog, and Input Signal Isolation.

TABLE 1 – ELECTRICAL RATINGS

Model Number	Input Line Voltage (VAC-50/60Hz)	Armature Voltage (VDC)	Maximum Ac Load Current (RMS Amps)	Maximum DC Load Current (DC AMPS)	Maximum Power HP (KW)
KBPC-225	230	0 – 200	22.0	15	3 (2.25)

TABLE 2 – KBPC-225 GENERAL PERFORMANCE SPECIFICATIONS

PARAMETER (units)	SPECIFICATIONS	FACTORY SETTING
AC Line Input (VAC \pm 15%, 50/60 Hz)	230	—
Horsepower at 230 VAC Line (HP) [KW]	3 [2.25]	—
Armature Voltage Range at 230 VAC Line (VDC)	0 - 200 ⁽¹⁾	180 VDC
Field Voltage at 230 VAC Line (VDC)	200/100 ⁽²⁾	—
Ambient Temperature Range (°C)	0 - 45	—
Speed Range (Ratio)	50:1 ⁽³⁾	—
Load Regulation [Armature Feedback] (% Base Speed)	\pm 1	—
Load Regulation [Tachometer Feedback] (% Set Speed)	\pm 1	—
AC Line Voltage Regulation (% Base Speed)	\pm 0.5	—
ACCEL and DECEL Ranges (Seconds)	0.1 - 15	1
MIN SPEED Range (% Base Speed)	0 - 30	0
MAX SPEED Range (% Base Speed)	60 - 120	90
IR COMP Range at 230 VAC Line (VDC)	0 - 30	8
CL Range (% Range Setting)	0 - 180	150
Timed CL Range (Seconds)	0.5 - 15	7
Voltage Following Linearity (% Base Speed)	\pm 0.5	—

Notes:

- (1) Maximum recommended output voltage is 180 VDC at 230 VAC. Exceeding this output voltage will cause a reduction in load regulation performance.
- (2) For shunt wound motor with lower field voltage, use F1 and L1 connection.
- (3) Consult motor manufacturers for constant torque speed range of motor. (Typical speed range for most 3 HP motor is 20:1)

FIG. 1 – CONTROL LAYOUT

Illustrates Approximate Factory Setting of Jumpers and Trimpots

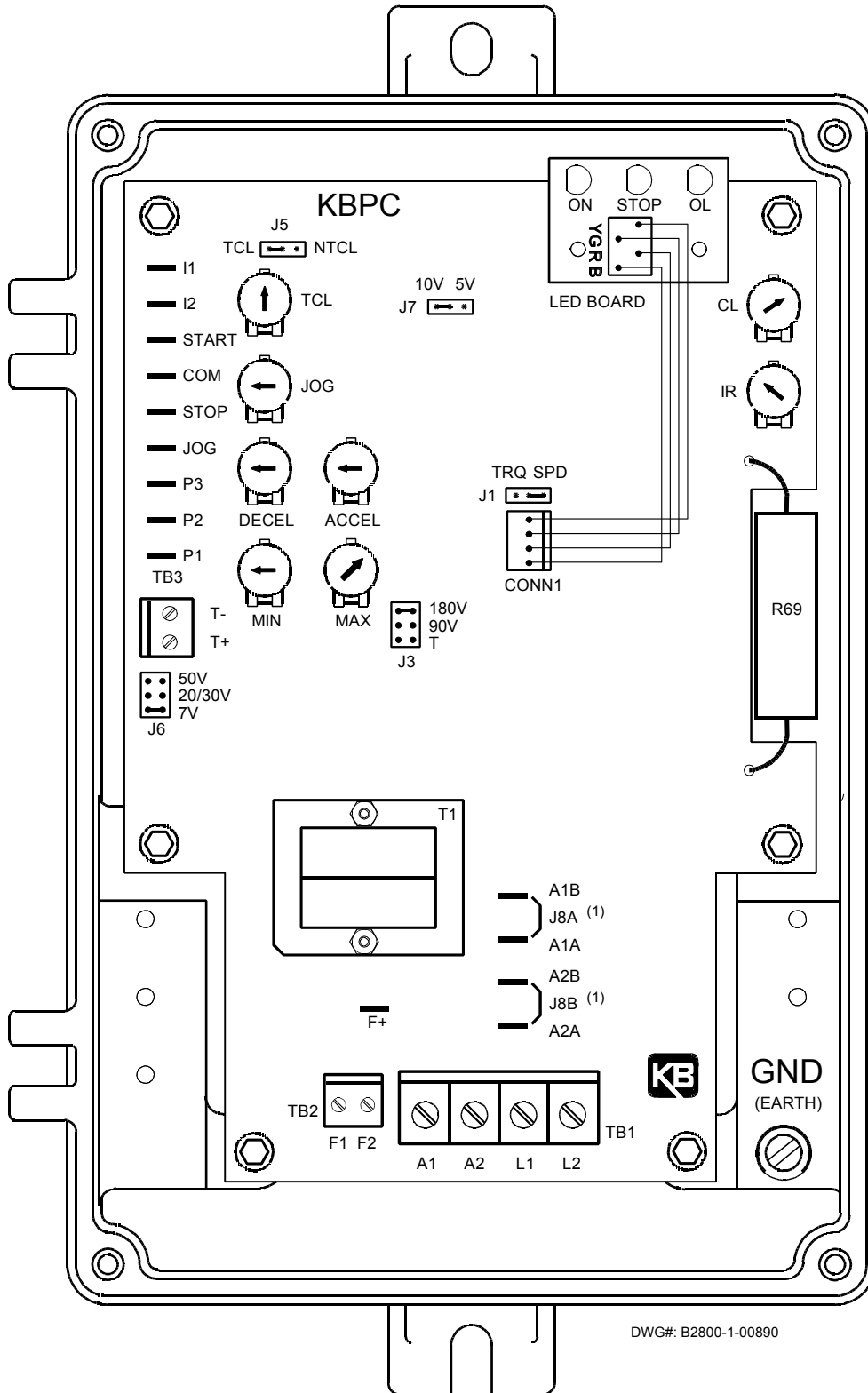

DWG#: B2800-1-00890

II. SETTING SPEED OR TORQUE MODE OF DRIVE (JUMPER J1)

- A. **Speed Control Mode** – When Jumper J1 is placed in the "SPD" position the drive will control motor speed as a linear function of the main potentiometer rotation or analog voltage input. The range of output speed can be adjusted with the MIN and MAX trimpots. The motor will maintain the preset speed as long as the maximum load does not exceed the current limit set point. If the motor load exceeds the current limit setting, the Overload LED will turn on and the motor will stall.

FIG. 2A – MOTOR SPEED vs. POTENTIOMETER ROTATION

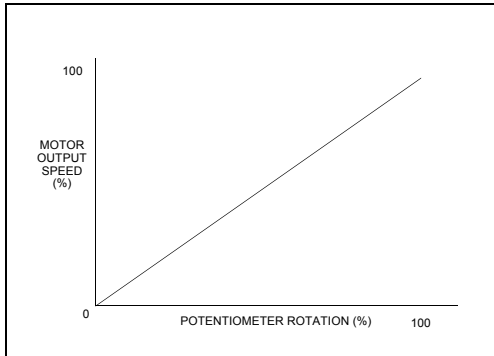
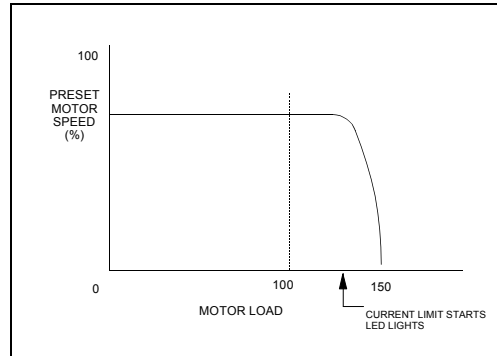

FIG. 2B – PRESET MOTOR SPEED vs. MOTOR LOAD



- B. **Torque Control Mode** – When Jumper J1 is placed in the "TRQ" position, the drive will control motor torque as a linear function of main potentiometer rotation. If the motor load exceeds the torque setting, the motor will stall, the Overload LED will light, and the drive will apply a constant preset torque based on the potentiometer setting. The Overload LED will light when the load torque approaches the current limit set point. The torque limits are set via the CL trimpot. Note: When operating in the Torque Mode, Jumper J5 must be in the "NTCL" position or drive will shut down when CL Timer times out.

FIG. 3A – MOTOR OUTPUT TORQUE vs. POTENTIOMETER ROTATION

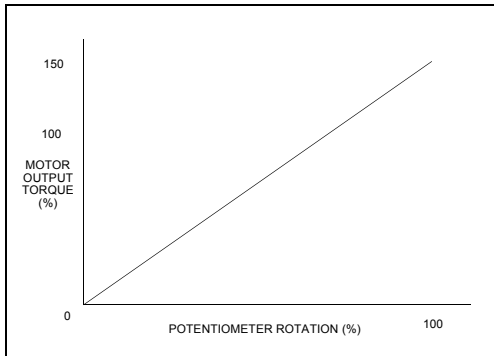
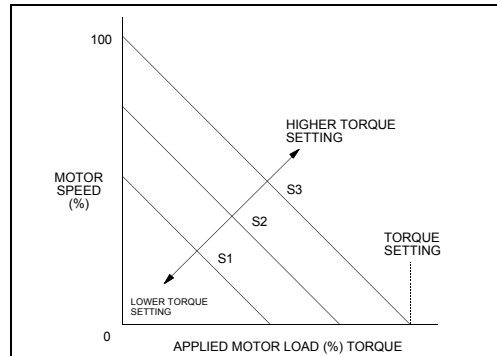

FIG. 3B – MOTOR SPEED vs. APPLIED MOTOR LOAD



III. SETTING SELECTABLE JUMPERS

This control has selectable jumpers which can be changed to accommodate various applications. **Note: Jumpers J2 and J4 have not been installed in this control. Jumper J1 is set in accordance with Section II.** Refer to Figure 1.

- C. **Tachometer Feedback (J3)** – The control is factory set for armature feedback which provides good load regulation for most applications. If superior load regulation is required, tachometer feedback can provide over 1% load regulation over a 50:1 speed range. If tachometer feedback is to be used, J3 must be placed in the "TFB" position and an external DC tachometer must be connected. See Sections III C. (p. 7) and V E. (p. 9) for additional information. Note: IR Comp trimpot must be turned to minimum position (full ccw).

B. J5 - Current Limit Mode – (Factory set for "TCL") This control contains electronic current limiting which limits the maximum DC current to the motor (the current limit set point is established with the setting of the CL trimpot). Two modes of current limit operation are provided:

1. Timed Current Limit "TCL" – In this mode the drive will turn off after being in current limit for a preset time. This time period is adjustable with the TCL trimpot from 0.5-15 seconds and is factory set for approximately seven (7) seconds. **This provides motor overload protection.**

Applicatin Note – After the control times out in TCL, it can be reset using the Start Switch by setting the switch to the "STOP" position and then to "START," or by disconnecting and reconnecting the AC line. If the Start Switch is jumpered out, the control can be restarted after timing out in TCL, by disconnecting and reconnecting the AC line. Note: The Overload lamp will remain lighted until the control is reset.

2. Non-Timed Current Limit "NTCL" – In this mode the drive will reach the preset current limit during overload and stay at that level until a fuse blows or the drive is manually turned off. If non-timed CL operation is desired, move jumper J5 from the factory set "TCL" position to the "NTCL" position. The NTCL position must be used when operating in the Torque Mode. See Sec. II B. (p.6).

C. J6 - Tachometer Voltage – (Note: Selection of this jumper position is not required if tachometer feedback is not used.) If tachometer feedback is used, select the J6 position (7V, 20/30V, 50V) which corresponds to the tachometer voltage in **Volts/1000 RPM**. The selection of J6 position is based on a maximum motor speed of 1800 RPM. If other than standard tachometer voltages and motor speeds are used, an external resistor (RT) may be used (1/2 watt rating).

1. Install resistor (RT) in series with either tachometer lead.
2. Place J6 in "7V" position.
3. Calculate the value of (RT) as follows:

$$RT = [(0.9 \times VT \times S) - 20,000] \text{ ohms} \quad VT = \text{Tach Voltage in Volts/1000 RPM}$$
$$S = \text{Base speed of motor in RPM}$$

Note: For tachometer feedback, Jumper J3 must be in the "TFB" position, and IR Comp trimpot must be set to minimum (ccw) position.

D. J7 - Signal Input Voltage – The output of this control is normally controlled with the main potentiometer. However, an **Isolated** analog voltage may also be used in place of a potentiometer. The control can be scaled for either a 0-5VDC or 0-10VDC by placing J7 in the appropriate position "5V" or "10V". The scaling can be further adjusted with the "Max" trimpot. (See Sec. V, F 2., (p. 9), for wiring information.)

Note: If an **Isolated** input signal is not available, an accessory Signal Isolator Model KBSI-240D (KB P/N 9431) can be installed. The KBSI-240D accepts a wide range of signal voltage and current. An Installation Kit containing Auto/Man Switch and required wiring is als available (P/N 9377).

IV. Mounting

Mount the control in a vertical position on a flat surface. Be sure to leave enough room below the bottom of the control to allow for the AC line and motor connections. Although the control is designed for outdoor and washdown use, care should be taken to avoid extremely hazardous locations where physical damage can occur. **Note: Do not use this control in an explosion proof application.** If the control is mounted in a closed, unventilated cabinet, remember to allow for proper heat dissipation. If full rating is required, a minimum enclosure size of 12" W x 24" H x 12" D should be used.

Front Cover - The KBPC case is designed with a hinge so that when the front cover is open, all wiring stays intact. To open the cover, the four cover screws must be loosened, so they no longer are engaged in the case bottom. Note that these screws are captive and the front cover holes are threaded. After mounting and wiring, close the front cover, making sure all wires are contained within the enclosure and the gasket is in place around the cover lip. Tighten all four cover screws so that the gasket is slightly compressed. **Do not overtighten.**

FIG. 4A – CAPTIVE SCREW TIGHTENED IN CASE

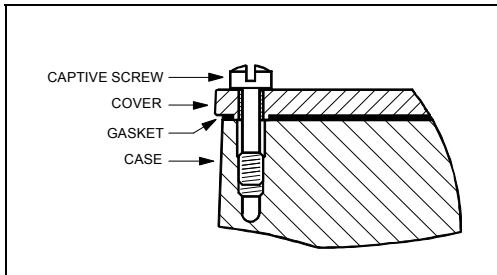
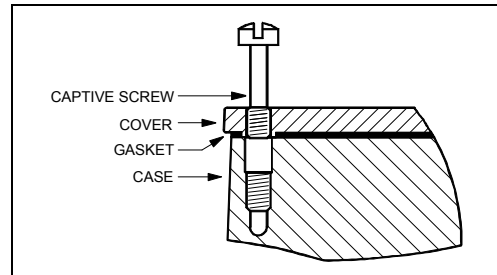

FIG. 4B – CAPTIVE SCREW ENGAGED IN FRONT COVER



V. WIRING



WARNING! – Read Safety Warning on page 3 before attempting to use this control.

Wire control in accordance with the National Electric Code requirements and other codes that apply. Be sure to fuse each conductor which is not at ground potential. **Do not fuse neutral or grounded conductors.** Note: See Section VI. Fusing (p.10). A separate AC line switch, or contactor, must be wired as a disconnect switch, so that the contacts open each ungrounded conductor. (See Fig. 5 for AC Line and Armature connection.)

To maintain the watertight integrity of the control, be sure to use suitable watertight connectors and wiring, which are appropriate for the application. Two .875" (22.2 mm) knockout holes are provided for a standard 1/2" knockout connector (not supplied) for wiring. A watertight plug is provided if only one knockout is required.

A. AC Line – Connect AC Line to terminals L1 and L2. Note: External 25A fuse must be added. See section VI (p. 10).

B. Motor Armature – Connect motor armature to terminals A1 (+) and A2 (-). Note: If motor operates in the wrong rotation, reverse the connection of armature leads A1 and A2.

WARNING! – Armature switching can cause catastrophic failure of motor and/or control. Therefore, do not wire switches or relays in series with the armature.

WARNING! – Electrical noise can cause erratic operation and/or control failure and therefore must be eliminated. Do not bundle AC and motor wires with other wires (e.g., potentiometer, analog input, Forward-Brake-Reverse, etc.). Shielded cables may have to be used for externally connected switches, potentiometers, analog inputs and tachometer wiring. **Do not ground shield or connect shield to any other wiring.**

C. Field [For Shunt Wound Motors Only]

Do not use terminals F1 and F2 for any other purpose than to power the field on a shunt wound motor. Connect motor shunt field to terminals F1 and F2 for 180 VDC motors with 200 VDC fields. For motors with half voltage fields (180 VDC motors with 100 VDC fields), connect field to terminals F1 and L1. See Table 3 for summary of Field Connections. See Figure 6A and Figure 6B (p. 9) for field wiring diagrams.

CAUTION – Shunt-Wound motors may be damaged if field remains connected without motor rotating for an extended period of time.

FIG. 5 – CONNECTION DIAGRAM

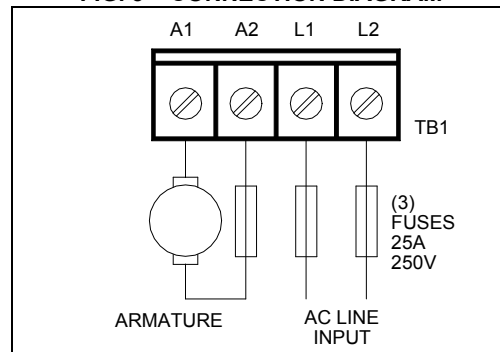

TABLE 3 – FIELD CONNECTIONS (Shunt Wound Motors Only)

AC LINE VOLTAGE	FIELD VOLTAGE (VDC)	FIELD CONNECTION	FIELD TYPE
230	200	F1, F2	Full Voltage
230	100	F1, L1	Half Voltage

FIG. 6A – FULL VOLTAGE FIELD

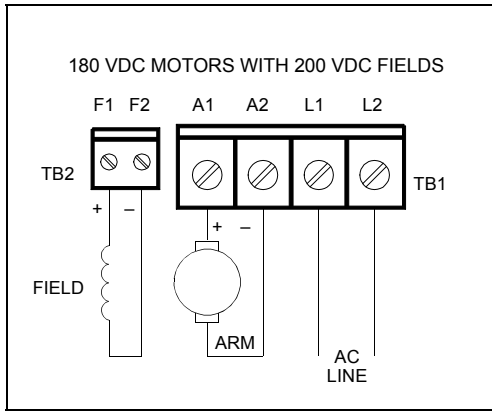
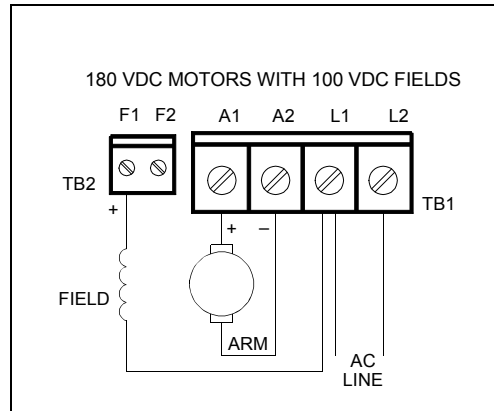

FIG. 6B – HALF VOLTAGE FIELD



- D. Ground** – Be sure to ground (earth) the control by connecting a ground wire to the Green Ground Screw located to the right of the terminal block. (See Fig. 1, p. 5)
- E. DC Tachometer Input** – If tachometer feedback is required, an analog tach signal must be connected to the terminal block TB3.

Note: For tachometer feedback, Jumper J3 must be set to the "TFB" position, jumper J6 must be set for the proper tach voltage, and the IR COMP must be set to minimum (ccw) position. (See Section III C, p. 7.)

Connect the tachometer so that when the motor rotates the positive tach voltage lead is connected to T+ and the negative tach lead is connected to T-. (See Fig. 7.)

Note: If the tach voltage is connected backwards, the control will drive the motor at full speed only. If the Forward-Brake-Reverse switch is used, provision must be made to reverse the polarity of the tachometer leads when the control is switched to "Reverse."

- F. Main Potentiometer** – The control is supplied with the main potentiometer prewired. However, the control can also be operated from a remote potentiometer, or from an **Isolated** analog voltage for voltage following. To operate from an external source remove **white, orange and violet** potentiometer leads from terminals P1, P2 and P3. The leads may be taped and left in the control. The potentiometer itself may be removed, provided a watertight seal is used to cover the hole in the front cover.

FIG. 7 – TACHOMETER CONNECTION DIAGRAM

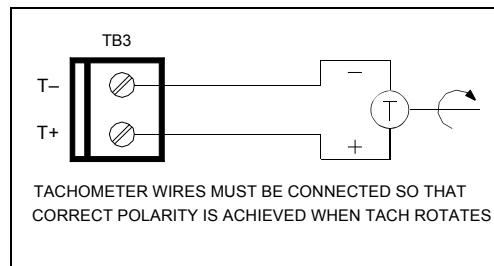

1. Remote Potentiometer – Connect remote potentiometer wires to terminals P1, P2 and P3, so that the "high" side of the potentiometer connects to P3, the "wiper" to P2 and the "low" side to P1. (See Fig. 8A p. 10)
2. Analog Input – An isolated 0 - 5 or 0 - 10 VDC analog voltage can also be used to drive the control. Note: If an isolated signal voltage is not available, an optional signal isolator can be installed (Model KBSI-240D, P/N 9431, see Fig. 14, p. 18, for signal isolator wiring diagrams). Connect the isolated input voltage to terminal P2 (positive) and P1 (negative). (See Fig. 8B, p. 10) Note: Be sure jumper J7 corresponds to proper range of input voltage 0 - 10 or 0 - 5 VDC. When the potentiometer is disconnected from P1, P2, P3 to connect an analog input signal, the MIN trimpot will have to be adjusted clockwise to achieve a 0⁺ output voltage.

FIG. 8A – REMOTE POTENTIOMETER CONNECTION

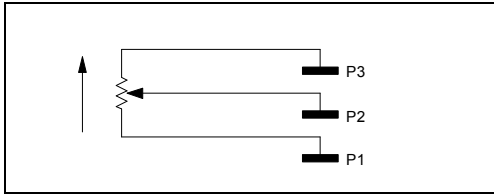
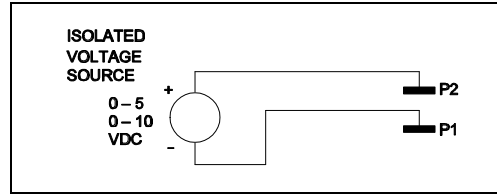

FIG. 8B – ANALOG VOLTAGE CONNECTION



G. Remote Start/Stop Switch – A remote Start/Stop Switch can be installed by removing the wires from the "Start," "Com" and "Stop" terminals, and reconnecting them to a remote switch. (See Fig. 9) Note: To eliminate Start/Stop function, join the "Start" and "Com" Quick Connect terminals with a jumper.

H. Inhibit – The control can be electronically stopped and started with the Inhibit circuit. To "Stop" the control, Terminals I1 & I2 must be joined via a contact. The control can be restarted by opening the contact. (See Fig. 10A)

Note: The Inhibit Circuit is not isolated. Do not common or ground inhibit leads.

I. Enable – The control can also be started and stopped with an Enable circuit (the Enable circuit functions opposite to that of the inhibit circuit; Inhibit: open to start, close to stop, Enable: open to stop, close to start). The Enable function is established by wiring a contact in series with the violet potentiometer lead connected to terminal P3. (See Fig. 10B) The Enable circuit is not isolated. Do not common or ground wiring.

WARNING! Do not use Start/Stop, Inhibit or Enable functions as a safety disconnect. Use only an AC Line disconnect for that purpose.

FIG. 9 – REMOTE START/STOP SWITCH CONNECTION

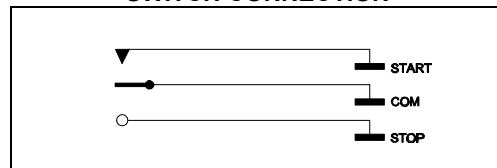

FIG. 10A – INHIBIT CIRCUIT WIRING

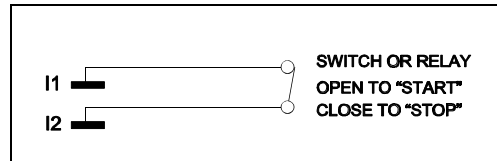
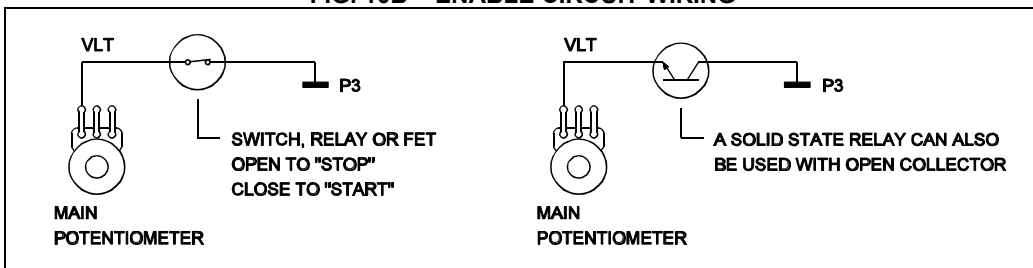

FIG. 10B – ENABLE CIRCUIT WIRING



Note: The MIN speed trimpot must not be set higher than 70% CW rotation (approx. 2:00 o'clock position) or Enable will not function.

VI. FUSING. (See Fig. 5, p. 8)

A. AC Line Fusing – Most electrical codes require that each ungrounded conductor contain fusing. Separate branch circuit fusing, or circuit breaker may be required. Check all electrical codes that may apply to the installation. This control does **not** contain AC line fuses. A 25 amp rated fuse or circuit breaker can be used.

B. Armature Fusing – It is suggested that an armature fuse be installed in series with an armature lead. Use a 25 amp 250V rated fuse or circuit breaker.

VII. OPERATION.



WARNING! Read Safety Warning on page 3 before attempting to operate the control or severe injury or death can result.

After the control has been set up properly (the jumpers set to the desired positions, and the wiring has been completed) the start-up procedure can begin. If AC power has been properly brought to the control the "ON" LED and the "STOP" LED indicators will be lighted. Before initially starting, be sure the main potentiometer is in the minimum position. To start the control move the Start/Stop toggle to the "Start" position and release. The "Stop" LED should extinguish and the motor should rotate as the potentiometer knob is rotated clockwise.

Note: If the motor rotates in the wrong direction, it will be necessary to disconnect the main AC power and reverse the armature wires. To stop the motor, move the Start/Stop toggle to the Stop position. If power is lost the control will not restart, unless the Start/Stop toggle is moved to the Start position.

VIII. TRIMPOT ADJUSTMENTS.

The control contains trimpots which have been factory adjusted for most applications. Figure 1 (p. 5) illustrates the location of the trimpots and their approximate adjustment positions. Some applications may require readjustment of the trimpots in order to tailor the control to exact requirements. (See Table 2, p. 4, for range and factory setting of all trimpots.) Readjust trimpots as follows:

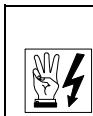

WARNING. Do not adjust trimpots with main power on if possible. If adjustments are made with power on, insulated adjustment tools must be used and safety glasses must be worn. High voltage exists in this control. Electrocution and/or fire can result if caution is not exercised. Safety warning must be read and understood before proceeding.

- A. Minimum Speed (MIN)** – The MIN trimpot is used to set the minimum voltage of the drive. This sets the minimum speed of the motor. Adjust the MIN trimpot as follows:
 1. Rotate Main Potentiometer to minimum speed position (full counterclockwise).
 2. Increase setting of MIN trimpot so that motor runs at desired minimum speed.

- B. Maximum Speed (MAX)** – The MAX trimpot is used to set the maximum voltage of the drive. This sets the maximum speed of the motor. Use the Max trimpot to change the factory setting. Adjust the MAX trimpot as follows:
 1. Rotate Main Potentiometer to maximum speed position (full clockwise).
 2. Adjust MAX trimpot setting to desired setting of motor speed.

- C. Acceleration (ACCEL)** – The ACCEL trimpot sets the amount of time it takes the control to reach full output. The accel circuit operates when rapidly rotating the main speed potentiometer to full clockwise position, or when starting the control when the main speed potentiometer is rotated clockwise. The trimpot is factory set to one (1) second. If more rapid acceleration is desired, rotate the trimpot counterclockwise. Note: Rapid ACCEL setting may cause the current limit circuit to activate which will extend the acceleration time. For a longer acceleration time, rotate ACCEL trimpot clockwise. 50% rotation represents approximately seven (7) seconds and full rotation is approximately fifteen (15) seconds.

- D. Deceleration (DECEL)** – The DECEL trimpot sets the amount of time it takes the control to go from full speed to minimum speed when rotating the main potentiometer CCW. The trimpot is factory set to one (1) second, and can be readjusted to full counterclockwise position for more rapid DECEL. Note: On high inertial loads, a rapid DECEL setting may cause the motor to coast to a stop slower than the DECEL setting. To increase deceleration time, rotate DECEL trimpot clockwise. 50% rotation represents approximately seven (7) seconds and full rotation is approximately fifteen (15) seconds. Note: The Decel circuit works when rotating the main speed pot in the CCW direction or when opening the P3 lead of the main pot or when placing the Start/Stop Switch toggle to the Stop position. It does not operate when power is removed.

- E. Current Limit (CL)** – This trimpot is used to set the maximum amount of DC current that the motor can draw. The amount of DC current determines the amount of maximum motor torque in both the Speed Control Mode and Torque Mode. The CL trimpot is factory set at 150% of the motor current (approx. 22 amps). Also see section IX C. Readjust the CL trimpot as follows:
1. When jumper J1 is set to the Speed Control Mode, the main potentiometer should be set at 50% rotation. When jumper J1 is set to the Torque Mode, the main potentiometer should be set at 100% of full rotation.
 2. Wire in a DC ammeter in series with armature lead. Lock shaft of motor.
 3. Apply power. Rotate CL trimpot CW until desired CL setting is reached (factory setting is 1.5 times rated motor current).

Caution:

1. **Adjusting the CL above 150% of motor rating can cause overheating and demagnetization of some PM motors. Consult motor manufacturer.**
2. **Do not leave the motor in a locked condition for more than a few seconds since armature damage may occur.**

- F. IR Compensation (IR)** – The IR comp circuit is used to stabilize motor speed under varying loads. (**Note: If control is in Tach Feedback mode, the IR trimpot should be set to minimum - ccw.**) Readjust the IR trimpot as follows:

1. Run the motor at approximately 30-50% of rated speed under no load and measure actual speed;
2. Load the motor to rated current. Rotate IR trimpot so that the loaded speed is the same as the unloaded speed measured in 1.

Control is now compensated so that minimal speed change will occur over a wide range of motor load. [Note: Too much IR Comp will cause unstable (oscillatory) operation.]

- G. Timed Current Limit (TCL)** – Jumper J5 must be in the "TCL" position, in order for Timed Current Limit to be operational. This trimpot determines the approximate amount of time the drive will stay in Current Limit before trip out. The trimpot has an adjustment range of .5-15 seconds and is factory set for seven (7) seconds. The trimpot can be reset according to the desired trip time. Rotating the trimpot clockwise increases the trip time. This function provides motor overload protection. (See p. 7, Section III, D 1, "Application Note," for TCL operation.)
- H. Jog Speed (JOG)** – This trimpot is operational only when the optional RUN-STOP-JOG Switch is installed (KB P/N 9340). In the JOG position the JOG trimpot can be adjusted to set the JOG speed.

IX. FUNCTION INDICATOR LAMPS

The control contains three function LED Indicator Lamps that reflect its operational status.

- A. Power On Indicator (ON)** – This lamp will glow GREEN when the AC line is connected to the control.
- B. Stop Indicator (STOP)** – This lamp will glow YELLOW when the control is placed in the STOP mode with the Start/Stop Switch.
- C. Overload Indicator (OL)** – When the motor is loaded to the current limit setpoint (CL setpoint is established by the setting and the CL trimpot), this lamp will glow RED. If the control is allowed to stay in CL and then trips out in Timed Current Limit, the OL LED will remain lighted until the control is restarted with the Start/Stop Switch. If the OL LED remains lighted during control operation, a fault condition may exist. Possible causes for this condition are as follows:
1. Motor is overloaded - check motor amps with DC ammeter in series with armature. (If motor is shunt type, field may be open or not receiving proper voltage.)

2. Motor may be defective - check motor for shorts or grounds.
3. The CL may be set too low - check position of CL trimpot.

NOTE: In some applications, especially those requiring the motor to cycle on and off or changing from one speed to another, the OL indicator may blink indicating a transient overload. This may be a normal condition for the application.

X. OPTIONAL ACCESSORIES

- A. RUN-STOP-JOG Switch (P/N 9340) –** This switch provides a momentary jog speed that can be used to "inch" a machine into position. It assembles easily to the control via quick connect terminals. A rubber switch seal is included in order to maintain watertight integrity.
- B. Signal Isolator (Model KBSI-240D, P/N 9431) –** Signal isolation is required when a remote nonisolated analog signal is to be used. Provision is made to install Model KBSI-240D on 4 bosses inside the front cover. The unit accepts a variety of voltage and current signals. **Note: Forward-Brake-Reverse Switch (P/N 9339) cannot be installed with Signal Isolator.**
- C. Auto/Manual Installation Kit (P/N 9377) –** This kit facilitates mounting of KBSI-240D Signal Isolator onto KBPC-225. Contains Auto/Man Switch and necessary wiring and hardware. (KBSI-240D, P/N 9431, purchased separately.)

Note: ON/OFF AC Line Switch, manual and electronic armature reversing with braking are not currently available for this product. Consult factory for future availability.

INCHES
[mm]

FIG. 11 – MECHANICAL SPECIFICATIONS

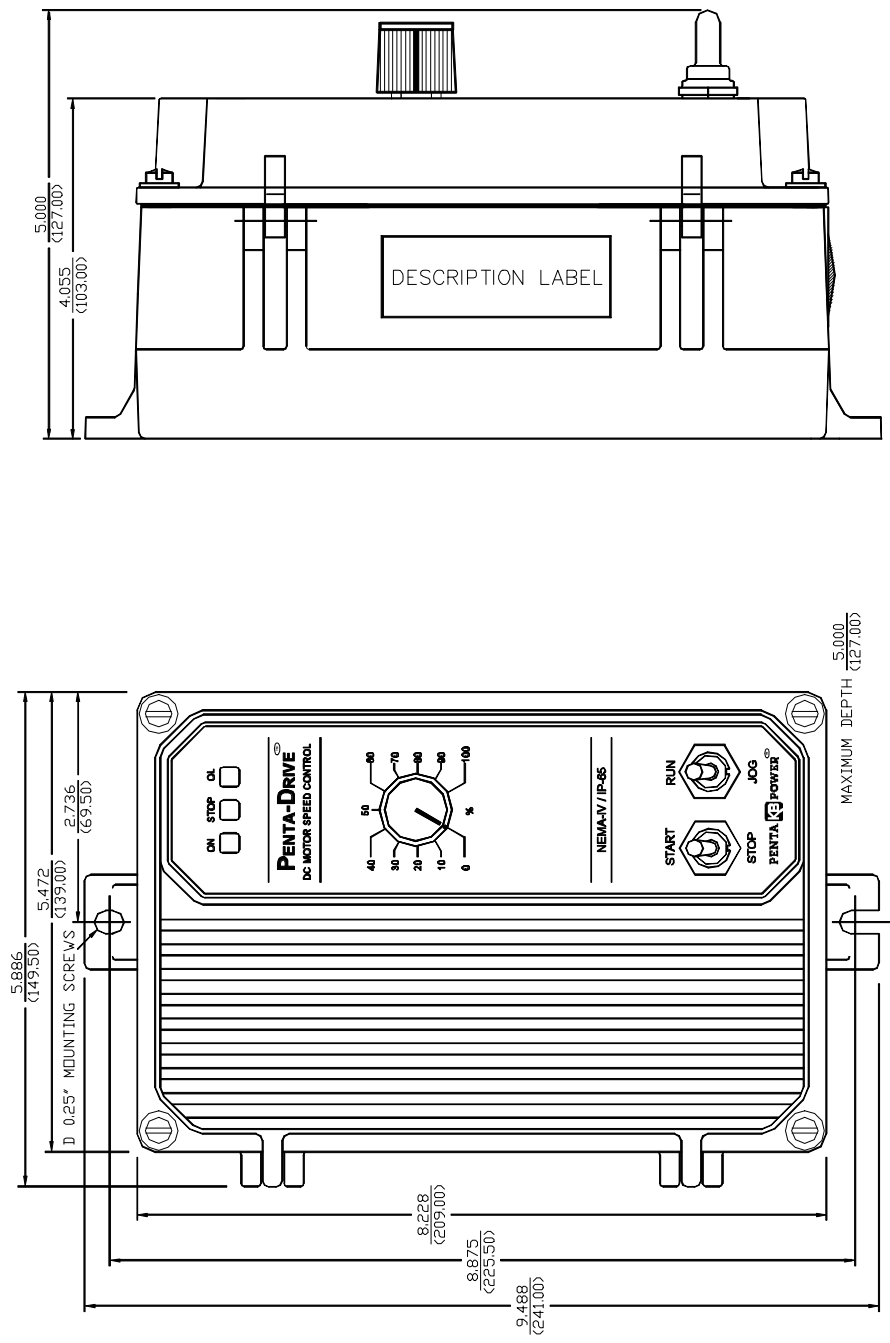
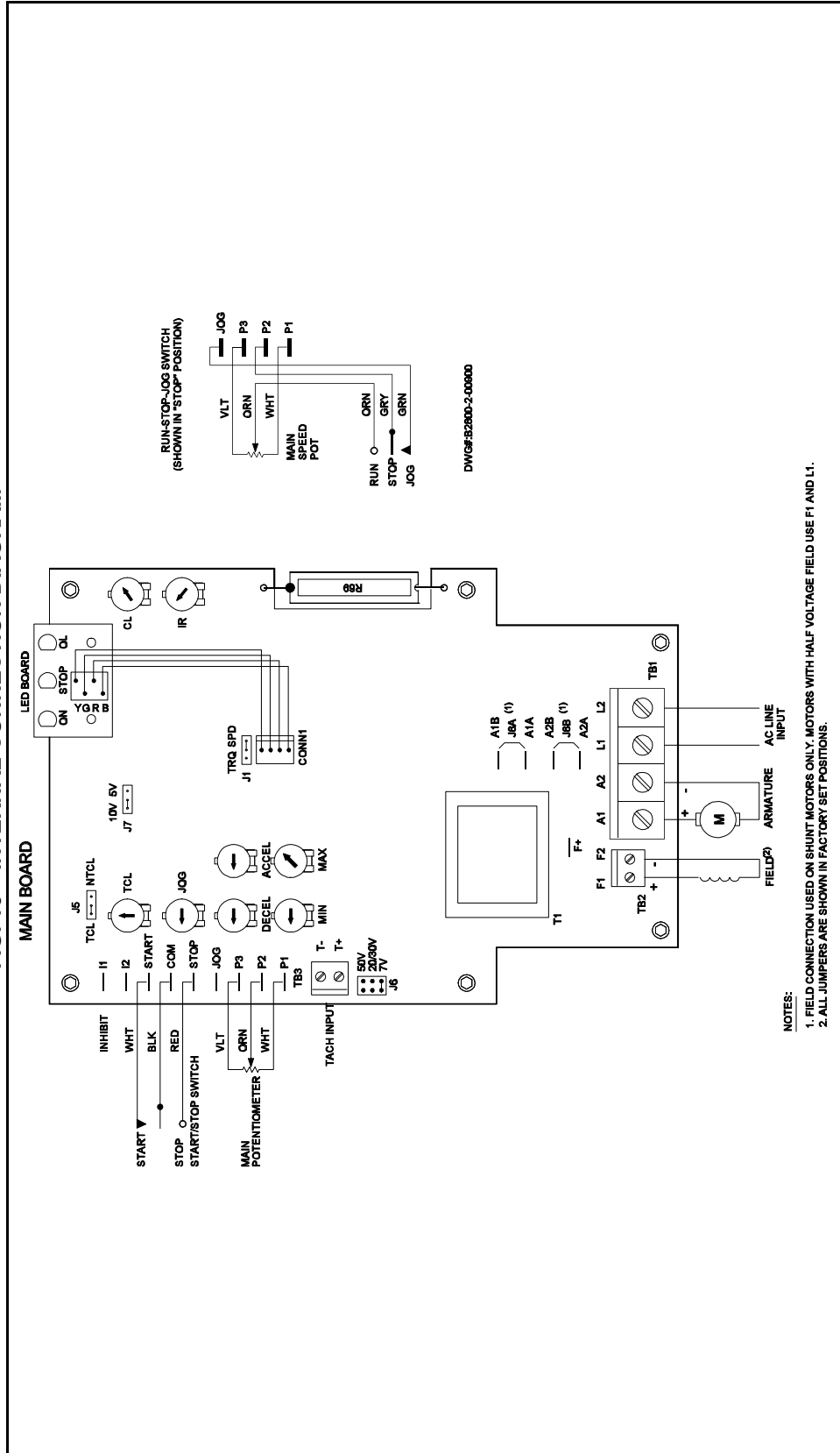
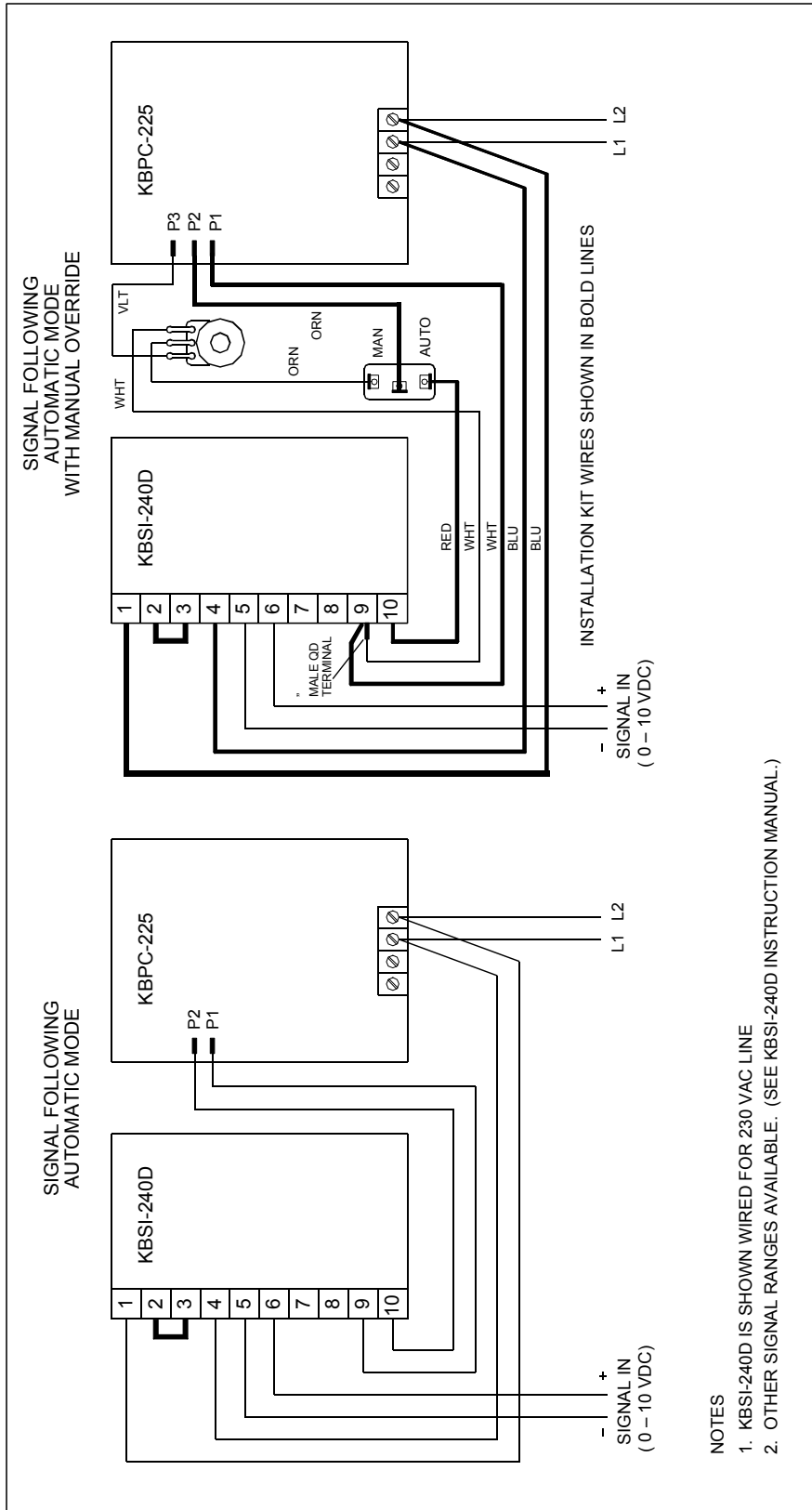

FIG. 13 – INTERNAL CONNECTION DIAGRAM



NOTES:
 1. FIELD CONNECTION USED ON SHUNT MOTORS ONLY. MOTORS WITH HALF VOLTAGE FIELD USE F1 AND L1.
 2. ALL JUMPERS ARE SHOWN IN FACTORY SET POSITIONS.

**FIG. 14 – CONNECTION DIAGRAMS
KBPC-225 WITH KBSI-240D SIGNAL ISOLATOR**



XI. – LIMITED WARRANTY

For a period of 18 months from date of original purchase, KB will repair or replace without charge devices which our examination proves to be defective in material or workmanship. This warranty is valid if the unit has not been tampered with by unauthorized persons, misused, abused, or improperly installed and has been used in accordance with the instructions and/or ratings supplied. The foregoing is in lieu of any other warranty or guarantee, expressed or implied, and we are not responsible for any expense, including installation and removal, inconvenience, or consequential damage, including injury to any person, caused by items of our manufacture or sale. Some states do not allow certain exclusions or limitations found in this warranty so that they may not apply to you. In any event, KB's total liability, under all circumstances, shall not exceed the full purchase price of this unit. (rev 4/88)



KB ELECTRONICS, Inc.

12095 NW 39th Street, Coral Springs, FL 33065 • (954) 346-4900 • Fax (954) 346-3377
Outside Florida Call **TOLL FREE** (800) 221-6570

1/10/96 Rev. A (A40350)