

## Warranty, Service & Repair

To register your product with the manufacturer, go to the Flowline website for on-line registration. The website address is as follows:

*www.flowline.com*

On-line Warranty Registration can be found under Contact Flowline on the Navigation Bar along the side of the home page.

If for some reason your product must be returned for factory service, go to the Flowline website listed above. Online Factory Service can be found under Contact Flowline on the Navigation Bar along the side of the home page. Click on **Return Authorization** to begin the registration process. You will need the following information at the time of registration:

1. Part Number and full Serial Number from product
2. Name and telephone number of someone who can answer technical questions related to the product and its application.
3. Return Shipping Address
4. Brief Description of the Symptom
5. Brief Description of the Application

Once you have received a Material Return Authorization number, ship the product prepaid in its original packing to:

Flowline Factory Service  
MRA \_\_\_\_\_  
10500 Humbolt Street  
Los Alamitos, CA 90720

To avoid delays in processing your repair, write the MRA on the shipping label. Please include the information about the malfunction with your product. This information enables our service technicians to process your repair order as quickly as possible.

# FLOWLINE®

## Ultrasonic Level Transmitter Model LU30 Owner's Manual



Version 4.2A

© 2007 FLOWLINE Inc.

All rights reserved.

Manual # MNU 30100 09/07 M4\_2

## WARRANTY

Flowline warrants to the original purchaser of its products that such products will be free from defects in material and workmanship under normal use and service for a period which is equal to the shorter of one year from the date of purchase of such products or two years from the date of manufacture of such products.

This warranty covers only those components of the products which are non-moving and not subject to normal wear. Moreover, products which are modified or altered, and electrical cables which are cut to length during installation are not covered by this warranty.

Flowline's obligation under this warranty is solely and exclusively limited to the repair or replacement, at Flowline's option, of the products (or components thereof) which Flowline's examination proves to its satisfaction to be defective. FLOWLINE SHALL HAVE NO OBLIGATION FOR CONSEQUENTIAL DAMAGES TO PERSONAL OR REAL PROPERTY, OR FOR INJURY TO ANY PERSON.

This warranty does not apply to products which have been subject to electrical or chemical damage due to improper use, accident, negligence, abuse or misuse. Abuse shall be assumed when indicated by electrical damage to relays, reed switches or other components. The warranty does not apply to products which are damaged during shipment back to Flowline's factory or designated service center or are returned without the original casing on the products. Moreover, this warranty becomes immediately null and void if anyone other than service personnel authorized by Flowline attempts to repair the defective products.

Products which are thought to be defective must be shipped prepaid and insured to Flowline's factory or a designated service center (the identity and address of which will be provided upon request) within 30 days of the discovery of the defect. Such defective products must be accompanied by proof of the date of purchase.

Flowline further reserves the right to unilaterally waive this warranty and to dispose of any product returned to Flowline where:

- a. There is evidence of a potentially hazardous material present with product.
- b. The product has remained unclaimed at Flowline for longer than 30 days after dutifully requesting disposition of the product.

THERE ARE NO WARRANTIES WHICH EXTEND BEYOND THE DESCRIPTION ON THE FACE OF THIS WARRANTY. This warranty and the obligations and liabilities of Flowline under it are exclusive and instead of, and the original purchaser hereby waives, all other remedies, warranties, guarantees or liabilities, express or implied. EXCLUDED FROM THIS WARRANTY IS THE IMPLIED WARRANTY OF FITNESS OF THE PRODUCTS FOR A PARTICULAR PURPOSE OR USE AND THE IMPLIED WARRANTY OF MERCHANTABILITY OF THE PRODUCTS.

This warranty may not be extended, altered or varied except by a written instrument signed by a duly-authorized officer of Flowline, Inc.

# SPECIFICATIONS

## Step One

Range:	0.5 to 24.5 feet (15 cm to 7.4 m)
Accuracy:	± 0.25% of span (air)
Resolution:	0.125" (3 mm)
Frequency:	50 kHz
Pulse rate:	8 pulses per second
Beam width:	8° conical
Blocking distance:	0.5' (15 cm) minimum
Display type:	4 segment LED
Display units:	Inch (cm)
Memory:	Non-volatile
Supply voltage:	14-36 VDC
Consumption:	200 mA
Current flow:	Source / sink
Signal output:	4-20 mA, three-wire
Signal invert:	4-20 mA / 20-4 mA
Signal averaging:	Fast / slow
Calibration:	Push button
Relay type:	(1) SPDT
Relay output:	250 VAC, 10A, 1/4 hp
Relay mode:	Selectable, NO or NC
Relay indication:	ON / OFF status
Contact resistance:	30 milliohm
Fail-safe diagnostics:	Relay reverts to safe position
Process temp.:	F: -4° to 140° C: -20° to 60°
Temp. compensation:	Automatic over entire range
Electronics temp.:	F: -40° to 140° C: -40° to 60°
Pressure rating:	30 psi (2 bar) @ 25 °C., derated @ 1.667 psi (.113 bar) per °C. above 25 °C.
Enclosure rating:	NEMA 4X (IP65)
Enclosure material:	Polypropylene, U.L. 94VO
Transducer material:	Polyvinylidene Fluoride
Cable jacket mat'l:	Vinyl
Cable length:	9" (22 cm)
Mounting threads:	2" NPT (2" G)
Mounting gasket:	Viton (metric only)
Conduit connection:	Single, 1/2" NPT
Classification:	General purpose
CE compliance:	EN 61326 EMC EN 61010-1 Safety

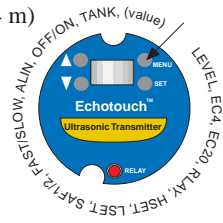

Holding down the [MENU] key will scroll the display in the following sequence.

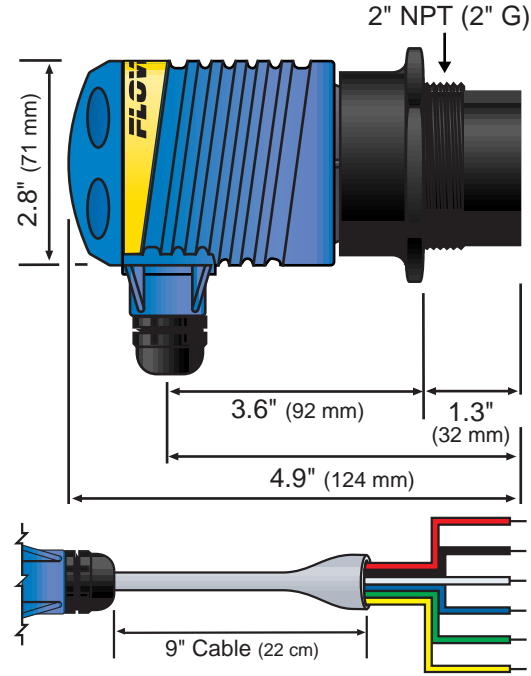

**Ultrasonic Transmitter**

**LU30 - 5 0**

**Mounting Thread**

- 0 - 2" NPT
- 6 - 2" G

**Switch Output**

- 3 - 4-20 mA, Sourcing
- 4 - 4-20 mA, Sinking

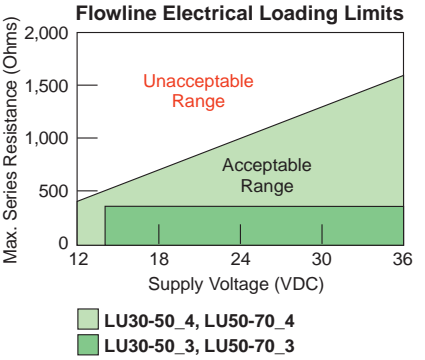
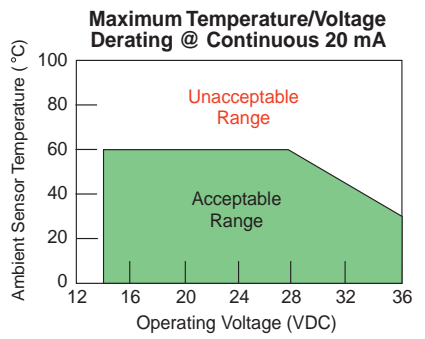
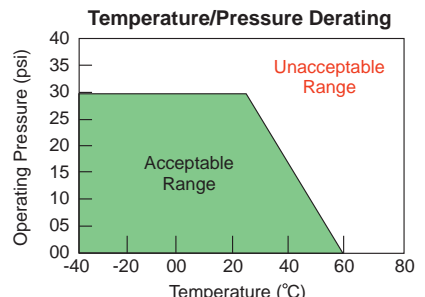

## Technology

An ultrasonic sound wave is pulsed eight times per second from the base of the transducer. The sound wave reflects against the process medium below and returns to the transducer. The micro-processor based electronics measure the time of flight between the sound generation and receipt, and translates this figure into the distance between the transmitter and process medium below.

## Sinking vs. Sourcing

The LU30 is manufactured in two different outputs, sourcing and sinking. A sourcing transmitter uses the negative of the power supply as the reference for the entire system. When using a sourcing unit, make sure the negative of the ground is the common for the entire system. A sinking transmitter uses the positive of the power supply as the reference for the entire system. When using a sinking unit, make sure the positive of the ground is the common for the entire system.

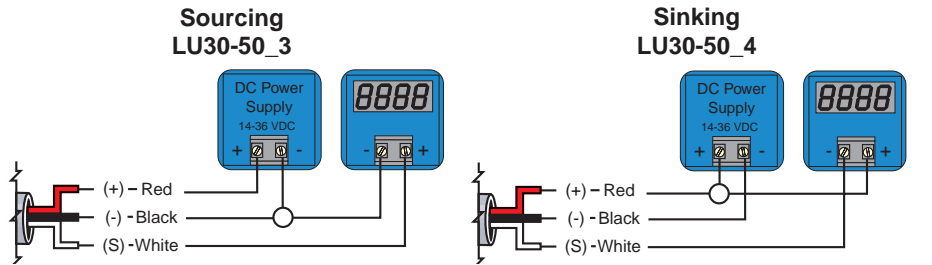

## SAFETY PRECAUTIONS

### Step Two

#### ⚠ About this Manual:

PLEASE READ THE ENTIRE MANUAL PRIOR TO INSTALLING OR USING THIS PRODUCT. This manual includes information on the continuous ultrasonic level transmitter from FLOWLINE; model LU30-50\_\_. Please refer to the part number located on the sensor label to verify the exact model which you have purchased.

#### ⚠ User's Responsibility for Safety:

FLOWLINE manufactures a wide range of liquid level sensors and technologies. While each of these technologies are designed to operate in a wide variety of applications, it is the user's responsibility to select a technology that is appropriate for the application, install it properly, perform tests of the installed system, and maintain all components. The failure to do so could result in property damage or serious injury.

#### ⚠ Proper Installation and Handling:

Because this is an electrically operated device, only properly-trained staff should install and/or repair this product. Use a proper sealant with all installations. *Note: Always install the 2" Viton gasket with the LU30-50\_\_. The G threaded version of the Echotouch will not seal unless the gasket is installed properly.* Never over-tighten the transmitter within the fitting. Always check for leaks prior to system start-up.

#### ⚠ Wiring and Electrical:

A supply voltage of 14-36 VDC is used to power the LU30 transmitter. The sensor systems should never exceed a maximum of 36 VDC. Electrical wiring of the sensor should be performed in accordance with all applicable national, state, and local codes.

#### ⚠ Temperature and Pressure:

The LU30 is designed for use in application temperatures from -20 °C (-4 °F) to 60 °C (140 °F), and for use at pressures up to 30 psi (2 bar) @ 25 °C, derated @ 1.667 psi (.113 bar) per °C above 25 °C.

#### ⚠ Material Compatibility:

The continuous ultrasonic level transmitter, LU30, is made of two materials. The enclosure is of Polypropylene (PP) and the transducer is made of Polyvinylidene Fluoride (PVDF). Make sure that the model which you have selected is chemically compatible with the application liquids. While the transmitter housing is liquid-resistant when installed properly, it is not designed to be immersed. It should be mounted in such a way that it does not normally come into contact with fluid.

#### ⚠ Flammable, Explosive and Hazardous Applications:

The LU30 level transmitter systems should not be used within flammable or explosive applications.

#### ⚠ Make a Fail-Safe System:

Design a fail-safe system that accommodates the possibility of transmitter or power failure. In critical applications, FLOWLINE recommends the use of redundant backup systems and alarms in addition to the primary system.

#### ⚠ Warning ⚠

The LU30-50\_3 is a sourcing transmitter which provides internal 4-20 mA excitation and should be used with a sinking device. The LU30-50\_4 is a sinking transmitter which requires external 4-20 mA excitation and should be used with a sourcing device.

When installing the LU30, never tighten the transmitter from the body. Always use the wrench flat located above the threads.

All measurement used for programming the LU30 are made from the bottom of the transmitter down.

## DEFINITIONS

### Step Three

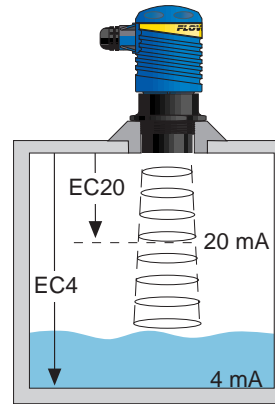

**EC4:** The 4 mA setting for the LU30. The EC4 is the distance from the bottom of the LU30 to the 4 mA set point. This setting is measured in either inches or centimeters on the display. The EC4 setting is typically greater than the EC20 setting.

**EC20:** The 20 mA setting for the LU30. The EC20 is the distance from the bottom of the LU30 to the 20 mA set point. This setting is measured in either inches or centimeters on the display.

**RLAY:** Indicator for the next two modes. The 10A relay is latched between the HSET and LSET points.

**HSET & LSET:** Sets the high point and low point for relay activation. Relay will energize when display value is greater than the LSET value. Relay will de-energize when display value is less than the HSET value. The HSET value is always less than the LSET value. To activate the relay from a single point, set HSET and LSET to the same value.

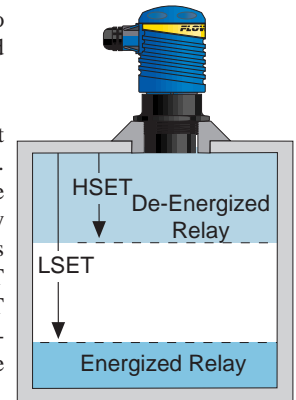

**SAF1/SAF2:** The 10A relay inside the LU30 can be used in a fail-safe design of your system. When [SAF1] is set, the relay will de-energize when the acoustic return signal is LOST. When [SAF2] is set, the relay will energize when the acoustic return signal is LOST. Response times will vary according to the setting of the LU30 ([FAST] or [SLOW] modes).

**FAST/SLOW:** FAST and SLOW sets the reaction time for the SAF1/2 setting. [FAST] is the typical setting for the LU30 to operate. The time for the RELAY to default is 30 seconds for [FAST] mode and 2.5 minutes for [SLOW] mode.

**ALIN:** Indicates that the unit is in the Alignment mode. Display will show the return signal strength in dB's. Used as an indicator for mechanical alignment of the LU30 and/or signal attenuation. Typical readings range between 2 and 60 dB's. For optimum alignment, first energize the unit and receive a valid return signal. Then select the ALIN mode and adjust the LU30 until the display is maximized.

**ON/OFF:** Actual setting for ALIN mode. The ALIN mode must be turned [OFF] when alignment is completed. This mode will not automatically default back to [LEVL].

**TANK:** Used as an indication for [TANK] or maximum range. The TANK sets the maximum tank height and will filter out all returns greater than this value.

**(value):** Actual TANK setting. The maximum distance is 288.0 inches.

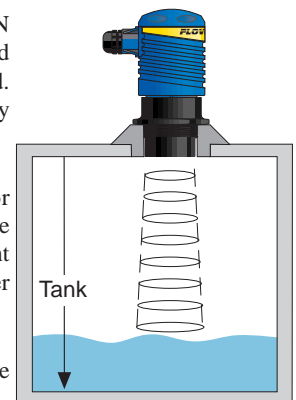

# PROGRAMMING

## Step Two

### EC4:

1. Hold [MENU] key until EC4 appears in display.
2. Release [MENU] key and wait until a value appears. This value is the current measured level value.
3. If this is acceptable, press [SET] to lock the value as the new EC4 set point. If not, press either the [▲] or [▼] keys once and the old setting for the EC4 will appear.
4. From here, use the [▲] or [▼] keys to raise or lower the value to the desired value.
5. Press the [SET] key to enter this value as the new EC4 set point.

### EC20:

1. Hold [MENU] key until EC20 appears in display.
2. Release [MENU] key and wait until a value appears. This value is the current measured level value.
3. If this is acceptable, press [SET] to lock the value as the new EC20 set point. If not, press either the [▲] or [▼] keys once and the old setting for the EC20 will appear.
4. From here, use the [▲] or [▼] keys to raise or lower the value to the desired value.
5. Press the [SET] key to enter this value as the new EC20 set point.

### HSET/LSET:

1. Hold [MENU] key until HSET or LSET appears in the display.
2. Release [MENU] key wait for the display to change to a number.
3. From here, use the [▲] or [▼] keys to raise or lower the value to the desired value.
4. Release all buttons and the value will be entered into memory. [SET] button does not need to be pressed.
5. Repeat process for the other setting.

### SAF1/SAF2:

1. Hold [MENU] key until SAF1 or SAF2 appears in the display.
2. Release [MENU] key and hold [SET] key to toggle between SAF1 and SAF2.
3. When desired setting is reached, release [SET] key. The last displayed setting will be locked into memory. To change, start again at step 1.

### FAST/SLOW:

1. Hold [MENU] key until FAST or SLOW appears in the display.
2. Release [MENU] key and hold [SET] key to toggle between FAST and SLOW.
3. When desired setting is reached, release [SET] key. The last displayed setting will be locked into memory. To change, start again at step 1.

### ALIN:

1. Hold [MENU] key until ALIN appears in the display.
2. Continue to hold [MENU] key until OFF appears in the display.
3. Release [MENU] key and hold [SET] key to toggle from OFF to ON.
4. Release [SET] key. The LU30 is now in ALIN mode.
5. To exit ALIN mode, repeat steps 1-4 changing from ON to OFF.

### TANK:

1. Hold [MENU] key until TANK appears in the display.
2. Continue to hold [MENU] key until a value appears in the display. This value is the current TANK setting.
3. If this is acceptable, press [SET] to lock the value as the TANK setting. If not, use the [▲] or [▼] keys to raise or lower the value to the desired setting.
4. Press the [SET] key to enter this value as the new TANK setting.

# WIRING

## Step Three

The Echotouch requires 14-36 VDC power with at least 200 mA supply in order to operate.

### 1. Wiring to a FLOWLINE Continuous Controller (Model LC52):

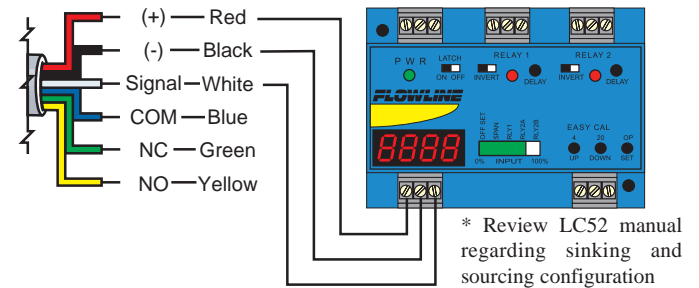

### 2. Wiring to a Two-Wire Loop Indicator (Model LU30-5004):

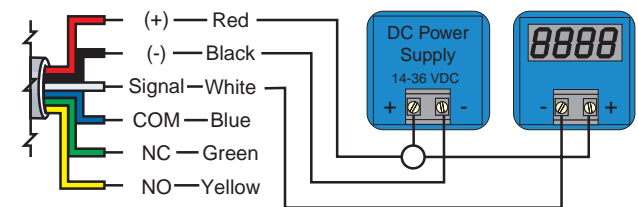

### 3. Wiring to a Two-Wire Loop Indicator (Model LU30-5003):

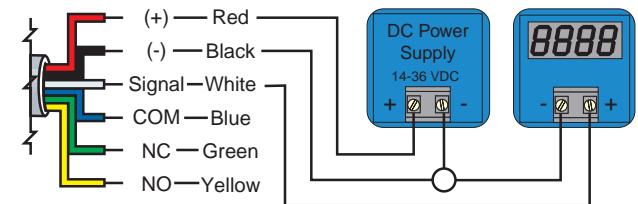

### 4. Wiring to a PLC (LU30-5004):

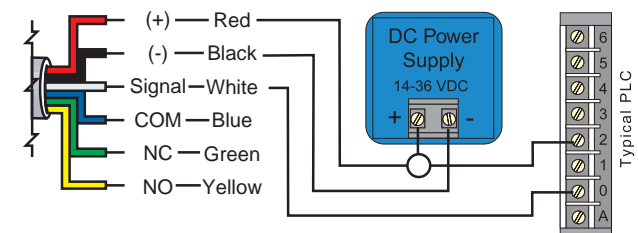

### 5. Wiring to a PLC (LU30-5003):

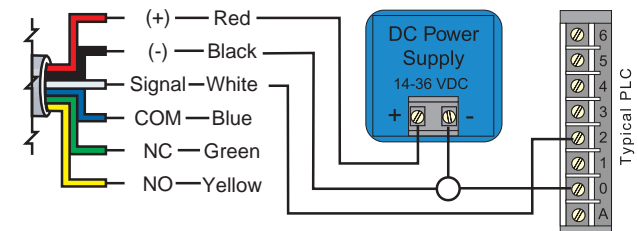

# INSTALLATION

## Step Six

Mounting the LU30 properly is critical to operation. If the LU30 is installed such that it is recessed in a fitting or flange, follow the criteria listed below. For an I.D. less than 3", do not recess the LU30 more than 1" for best results.

Flange I.D. (Inches)	Flange I.D. (Inches)
3	3
4	7
5	11
6	15
7	19
8	26

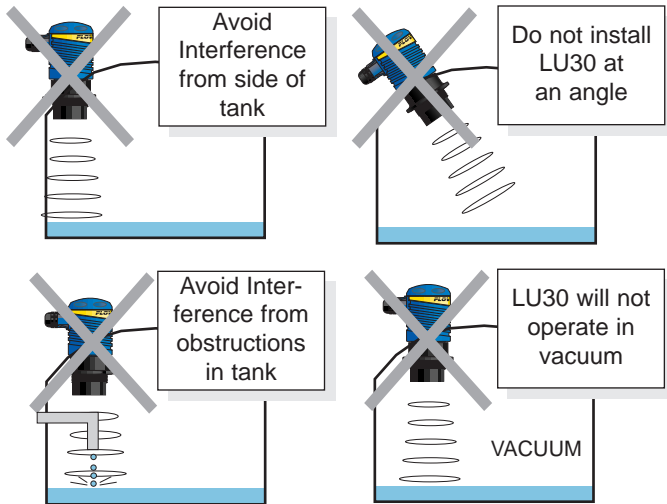
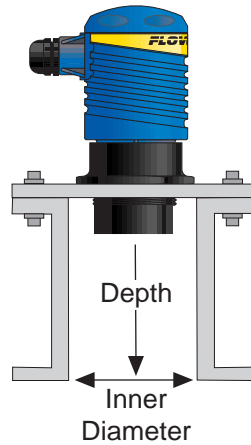

## Maximum Application Range

The maximum range of Echotouch™ is 24.5 feet at 110 dB. Yet a number of factors can reduce the overall quality of signal return and shorten the accurate range of the transmitter. To determine the maximum application range of the product, follow the signal return formula against the echo attenuation graph below.

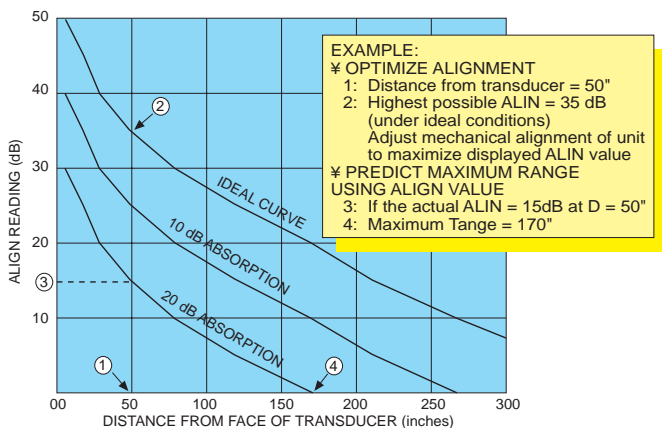

# INSTALLATION

## Step Seven

### Factory Settings:

The LU30 sensor is preset at the factory. When powering up the sensor the first time, the factory settings will be active. If at any time you need to return to these settings, remove power from the sensor and wait 10 seconds. Press the [Set] and [Menu] buttons simultaneously while powering up the sensor.

LEVL	INCHES (cm)	SAF1/2	SAF1
EC 4	288" (731.2 cm)	F/S	FAST
EC20	8" (20.3 cm)	ALIN	N/A
RLAY	N/A	OFF/ON	OFF
HSET	5" (12.6 cm)	TANK	N/A
LSET	288" (731.2 cm)	value	288" (731.2 cm)

### Changing Display Units:

The LU30 comes preset to measure in inches. To change the unit to display centimeters, remove power to the unit and wait 10 seconds. Press [▲] and [Set] simultaneously while powering up the sensor. The LU30 will now read in centimeters. To return to inches, remove power and wait 10 seconds. Press [▼] and [Set] simultaneously while powering up the sensor.

Depth (Feet)	Radius (Inches)	Radius (cm)
1'	1.2"	3.1 cm
2'	2.1"	5.2 cm
3'	2.9"	7.3 cm
4'	3.7"	9.5 cm
5'	4.6"	11.6 cm
6'	5.4"	13.7 cm
7'	6.2"	15.9 cm
8'	7.1"	18.0 cm
9'	7.9"	20.1 cm
10'	8.8"	22.3 cm
11'	9.6"	24.4 cm
12'	10.4"	26.5 cm
13'	11.3"	28.7 cm
14'	12.1"	30.8 cm
15'	13.0"	32.9 cm
16'	13.8"	35.1 cm
17'	14.6"	37.2 cm
18'	15.5"	39.3 cm
19'	16.3"	41.3 cm
20'	17.2"	43.6 cm
21'	18.0"	45.7 cm
22'	18.8"	47.8 cm
23'	19.7"	50.0 cm
24'	20.5"	52.1 cm
25'	21.4"	54.2 cm



### Warning

Always install the 2" Viton gasket with the LU30-50\_\_. The G threaded version of the Echotouch will not seal unless the gasket is installed properly.

When installing the LU30, never tighten the transmitter from the body. Always use the wrench flat located above the threads.

## INSTALLATION

### Step Eight

#### Internal Relay:

The LU30 series contains a 250 VAC, 10A, 1/2 Hp internal relay. The relay is actuated by the HSET and LSET settings. While this manual offers some examples and suggestions to help explain the operation of the relay, such examples are for information only and are not intended as a complete guide to installing any specific system.

#### High Level Alarm:

The goal is to make sure the liquid does not rise above a certain point. If it does, an alarm sounds alerting the operator to a high level condition. Wire the hot lead of the alarm to the Green NC relay wire. Also make sure the HSET and LSET settings are programmed correctly. Typically the values are set at the same distance away from the LU30. In the normal operation state, the LU30's relay will remain energized, keeping the alarm circuit open. When the alarm level has been reached, the relay de-energizes and activates the alarm. To change to a **low level alarm**, re-wire the alarm from the Green NC wire to the Yellow NO wire.

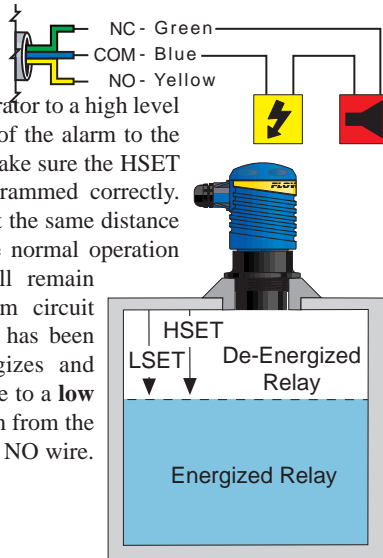

#### Automatic Fill:

The goal is to fill the tank. A valve is opened (energized) when a low level is reached and closed (de-energized) when a high level is reached. Wire the hot lead of the valve to the Yellow NO relay wire. Make sure the HSET and LSET settings are programmed correctly. Typically the values are set with the HSET as the valve close and the LSET as the valve open. A pump or solenoid can be substituted for the exact same operation. When the low level is reached, the system will start to fill the tank. The tank will continue to fill until the level reaches the high point. The system stops filling until the low level is reached again. To change to an **automatic empty** application, re-wire the system from the Yellow NO wire to the Green NC wire.

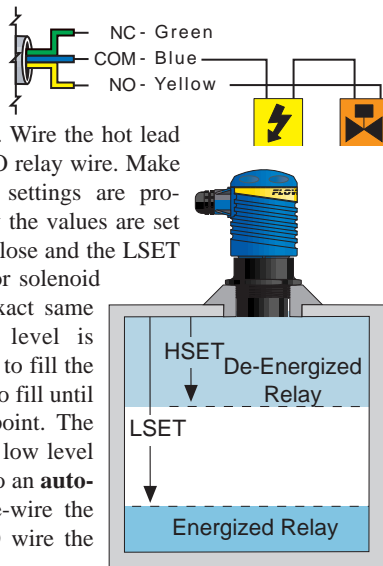

## MAINTENANCE

### Step Nine

#### LOST Signal:

A reading of LOST in the display of the LU30 indicates the transmitter is not receiving a valid return signal. If LOST appears, please check the following troubleshooting items:

1. Beam cone interference such as the side wall, ladders, seams, rungs or pipes within the LU30's beam cone.
2. Proper installation such that the LU30 is installed level and free from interference from the installation fitting.
3. Sufficient power being supplied to the LU30. The LU30 requires 14-36 VDC power with a minimum supply of 200 mA.
4. Proper programming of the TANK function. For best results, set the TANK function as the distance from the bottom of the tank to the bottom of the transmitter.
5. Make sure that the transmitter is not installed at an angle. Even a 5 degree offset can reduce the signal return strength greatly.

#### Current is always 4mA or 20 mA:

If the output of the LU30 is always reading 4mA or 20 mA, check the input values for the LU30. The display of the LU30 reads to the 1/10 of an inch or cm. A display of 1234 is 123.4" and not 1234".

#### Other Hints:

When checking the EC4 and EC20 values, the first value which appears after EC4 or EC20 is the current distance from the bottom of the transmitter to the surface of the liquid. Pressing either the [▲] or [▼] buttons will then show the actual value in memory.

#### General:

The LU30 series sensor itself requires no periodic maintenance except cleaning as required. It is the responsibility of the user to determine the appropriate maintenance schedule, based on the specific characteristics of the application liquids.

#### Cleaning Procedure:

1. **Power:** Make Sure that all power to the sensor, controller and/or power supply is completely disconnected.
2. **Sensor Removal:** In all through-wall installations, make sure that the tank is drained well below the sensor prior to removal. Carefully, remove the sensor from the installation.
3. **Cleaning the Sensor:** Use a soft bristle brush and mild detergent, carefully wash the LU30 series sensor. Do not use harsh abrasives such as steel wool or sandpaper, which might damage the surface sensor. Do not use incompatible solvents which may damage the LU30's Polypropylene or PVDF plastic body.