



PRODUCT MANUAL
CONTINUOUS LEVEL CONTROLS

7330 Pro-Stik II

MAGNETOSTRICTIVE LEVEL SYSTEM



**ABSOLUTE PROCESS CONTROL
KNOW WHERE YOU ARE... REGARDLESS**

7330 Pro-Stik II

The **BW Controls 7330 Series Magnetostrictive Level System** is an integral assembly that measures linear motion or liquid level using magnetostrictive technology. A single level output is provided with field configurable 4mA and 20mA points in an intrinsically safe, standard two wire loop-powered configuration.

Magnetostrictive technology is extremely accurate and requires no calibration during installation. The sensor works equally well on all clean liquids with a viscosity of 1500 centipoises or less. Various types of Floats are available for different applications.

Unlike conventional level instruments, the electronics are incorporated into the measuring probe and there is no external electronic housing. This design utilizes sophisticated Surface Mount Technology (SMT) integrated into a 5/8" diameter tube, reducing user's cost and offers greater options for insertion and mounting. The self-contained unit provides IP68 protection in a 316 stainless steel enclosure.

The 7330 Pro-Stik II offers unique diagnostic capabilities. The normal 4 to 20mA output indicates the position of the float within the span. If the level is outside of the set span, the output is either 3.9mA or 20.1mA. If the float moves into the Null or Dead Zones or there is a sensing failure, then the output is 3.8mA

Unpacking

Carefully remove the contents of the shipping carton and check each item against the packing list before destroying the packing materials. Any damage must be reported to the shipping company. If you do not receive all of the parts on the packing slip, contact Ametek at 800-635-0289 (US and Canada) or 248-435-0700 (International).

Most rigid probes are shipped in a Tube. To remove the metal end cap, use a large, flat blade screw driver

or a metal rod and tap on the inner edge of the cap until it pivots. Grab the cap and pull it out. Use caution as the edge of the metal cap may be sharp.

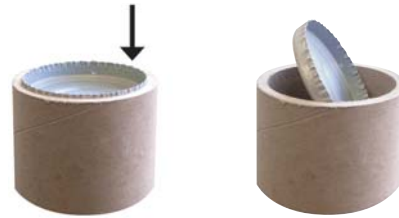

If you have an RMA warranty claim, pack the probe in a shipping tube or with stiff reinforcement to prevent the probe from being bent in transit.

Mounting Conditions

1. The 7330 Pro-Stik II Series level system is designed for industrial applications, but should be mounted in a location as free as possible from vibration, corrosive atmospheres, or any possibility of mechanical damage.
2. Mount the probe in a reasonably accessible location, away from agitation.
3. Ambient measurement temperature should be between -40°F and 158°F (-40°C to 70°C).
4. Mount the probe perpendicular with gravity so the float moves freely along the probe.

CAUTION

When installing probes, do not bend rigid probes. Permanent damage may result. Rigid probes, longer than 10 ft., need to be supported at both ends while handling. Remove the Caution Tag before installing. Probes are built with the electronic circuits sealed inside the tube at the factory. Do not attempt to open probe or weld on the tube.

5. The Float Retention Clip should be in place at base of probe after the float is on the tube and the float is moving smoothly up and down the probe.

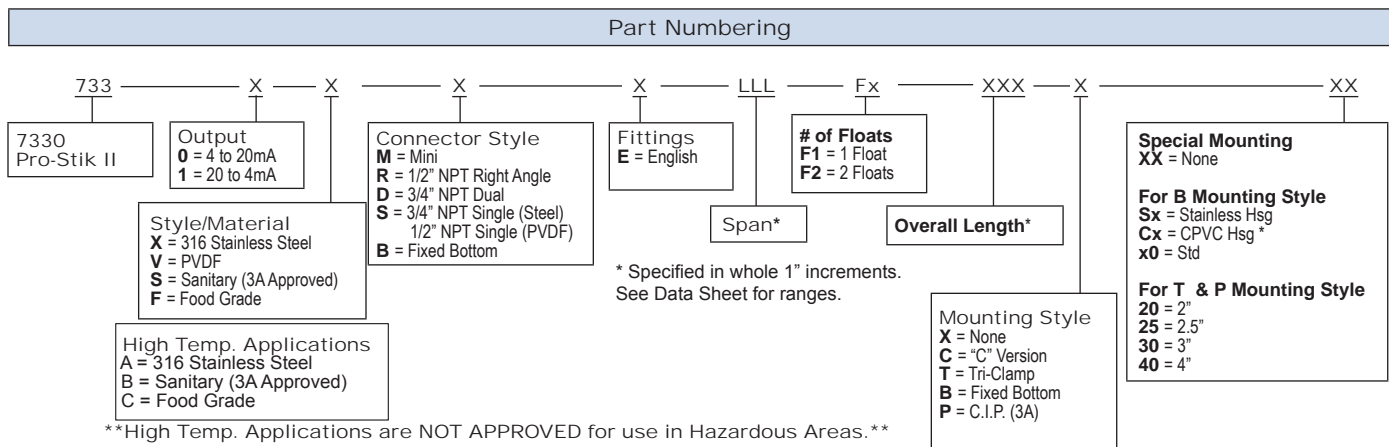

Installation of a Rigid Probe

Installation of Stainless Steel Probe

1. Insert bottom end of probe into tank.
Do not allow the float to drop suddenly since it can damage the retainer at end of probe.
2. Thread bushing into tank or flange. Bolt flange into position.
3. Thread compression fitting into bushing or flange.
4. Hand tighten. To insure compression fitting is sealed, turn fitting ¼ turn after hand tightening.

Make final check to see that all bolts and screws are in proper position and probe is securely tightened.

Installation of Flex Probe

Special instructions are provided for the installation of PVDF probes. See the Flex Probe Installation & Handling Procedure document Z190.

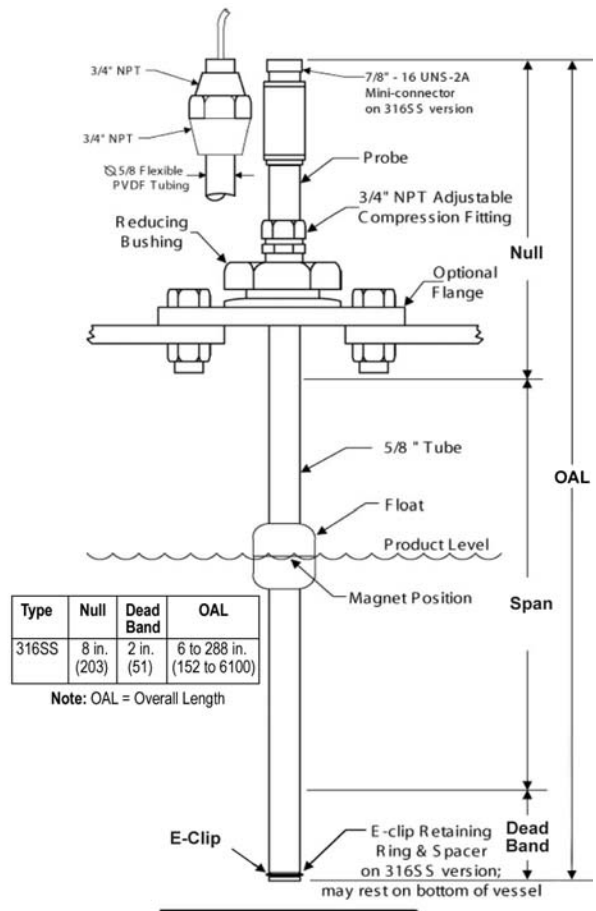
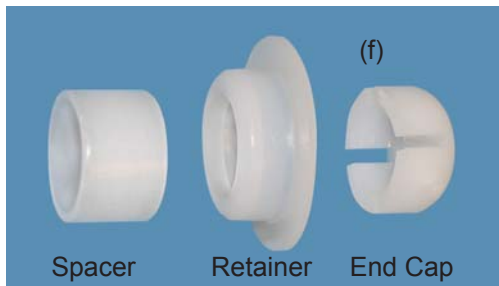

Type	Null	Dead Band	OAL
316SS	8 in. (203)	2 in. (51)	6 to 288 in. (152 to 6100)

Note: OAL = Overall Length

Typical Installation

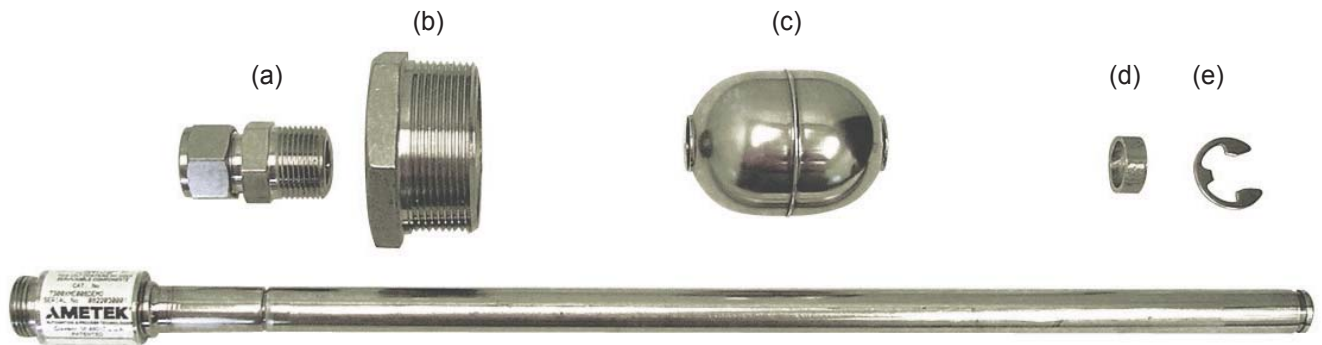

Accessories (Purchased separately)

- (a) Compression Fitting, 5/8" to 3/4" NPT, Stainless Steel
- (b) Adapter Bushing, 2" NPT to 3/4" NPT, Stainless Steel
- (c) A 2 inch, 316 Stainless Steel float.
- (d) A 316 SS Spacer to insure the float-magnet is always in the active span.
- (e) A 316 SS "E-Clip" to hold float on to the probe.
- (f) ECTFE (Ethylene Chlorotrifluoroethylene) 2 piece Halar® end cap with spacer. A plastic end cap is recommended when probe is resting on the bottom of a metal tank.

Halar® is a Registered Trademark of Ausimont USA, Inc.

Installation of Accessories

1. The normal sequence for assembly of the probe is as follows:
 - a. Slide on compression fitting (a) for Style S, M or R probe.
OR
 - b. Slide reducing bushing (b) or flange (customer supplied) on for Style D probe.
2. Slide float (c) onto probe. Magnet is located in middle of 316 SS float, so orientation of float does not make any difference.
3. Slide spacer (d) onto the tube.
4. Capture all of these parts with E-Clip (e) or ECTFE end cap (f). The Halar® end cap is held in place by the retainer.

Installation of PVDF Probe

CAUTION

NOTE: The surface of the isolating material (PVDF) exceeds the limit of 4cm² as specified in EN60079-26, and the probability of electrostatic charging needs to be considered for use in category 1 (Zone 0).

Also, refer to separate Flex Probe Installation & Handling Procedure document Z190 which is shipped with the probe.

Assembly is basically the same as for the steel probe. However, two people are recommended for assembly of the 7330 Flex Probe; one to hold the probe and the other to assemble components.

During unpacking and installation, always keep the coils parallel. Do not let the diameter of the coils become less than 40 inches (approx. 1 meter).

CAUTION

Kinking a probe is considered user damage and NOT covered by warranty!



DO NOT bend top of probe!



DO NOT support probe by electrical cable!



1. Using a side cutter, cut the tie wrap at the end of the probe.
2. Slide reducing bushing or flange (supplied by customer) on for Style D probe.
3. Slide float onto probe. On a symmetrical steel float, the magnet is located in the middle of the float, so orientation does not matter.
4. Slide weight or spacer on the probe and capture all of these parts with the SS pin.

NOTE: The span is set at the factory, however, if it is necessary to adjust or reset the span before installation, refer to the section on Setting the Span first, then two people should uncoil the probe in a flat area the length of the probe. Cut one tie wrap at a time in sequence. When recoiling the probe, be careful to keep the coils parallel and not to let the diameter of the coils become less than 40 inches (approx. 1 meter). Tie wraps to hold the coils are recommended.

5. Lower the weight and float end into the tank. Two people are needed; one to hold the assembled section of the probe and guide the probe into the tank, and the other to keep the coils parallel and unwrap them. Start with tie wrap #1.



6. After the float and weight are in the tank, thread bushing into tank or bolt flange into position.
7. If a threaded compression fitting is used, hand tighten it. Insure compression fitting is sealed. Turn the fitting 1 ¼ turns after hand tightening. Do not over tighten.
8. Make a final check to see that all of the bolts and screws are in proper position and probe is securely tightened.

Setting the Span

Correlating Level

Once the magnetostrictive level probe has been installed, the output may not be scaled properly for the actual installation. The actual level and the position of the probe in the tank needs to be correlated. You might need to adjust the span to be consistent with actual tank conditions by using a reference value. No other "calibration" is required.

CAUTION

Before setting the span in a hazardous area, make sure that the programming wire is properly protected through a safety barrier. See the wiring instructions and Installation Drawing E0240200 on page 8 for proper connections.

The probe is shipped from the factory with the span

preset based on the probe length. Re-setting of the span is not required unless different 4mA and/or 20mA points are required by the application. The 20mA point can be set prior to setting the 4mA point. There is no specific order. The 4mA or 20mA position can be at either the top or bottom of the probe.

The Zero (4mA) or Span (20mA) setting can be changed at any time simply by following the appropriate steps below.

The span can be set with either the probe outside or inside the vessel. When the span is set in the vessel, the actual level position in the vessel is used to set the 4mA and 20mA positions. If this is not practical, then the probe can be calibrated outside the tank (i.e. "bench calibrated").

There is a **timing sequence** that is used to unlock the probe for programming. This is to insure that the span cannot be accidentally re-programmed by someone in the field. We recommend you use a watch with a second hand when setting the span, however, this may not be necessary.

Manual Setting of Span

1. Place the float at desired 4mA position and power up the probe.
2. The 4mA position is set by "shorting" the White Programming Wire to the Black "Loop -" Wire for 3 seconds, breaking the contact for 3 seconds, then shorting the White and Black wires for 2 seconds, then remove the short.
3. Place the float at desired 20mA position.
4. The 20mA position is set by "shorting" the White Programming Wire to the Black "Loop -" Wire for 3 seconds, breaking the contact for 3 seconds, then shorting the White and Red "Loop +" wires for 2 seconds, and then remove the short.
5. The Span is set.

CAUTION

6. During normal operation, electrically insulate the White Program wire to prevent accidental setting of span.

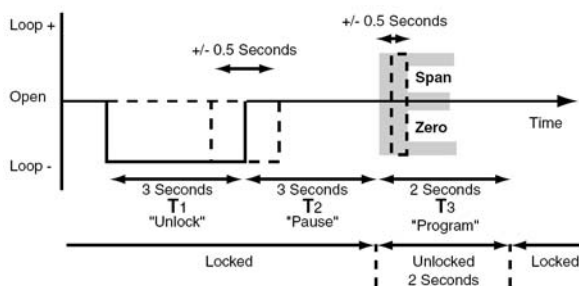

Security Timing Sequence

Optional Push Button Setting of Span

An optional housing with Zero and Span push buttons is available.

1. Place the float at 4mA position and push the Zero button and hold for 3 seconds, release the button for 3 seconds, then push the the Zero button again for 2 seconds
2. The 4mA position has been set.
3. Place the float to the 20mA position and push the Zero button and hold for 3 seconds, release for 3 seconds, then push the Span button for 2 seconds.
4. The 20mA position has been set.

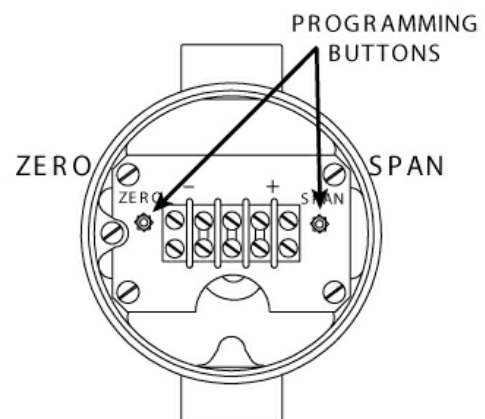

Wiring

Wiring Intrinsically Safe Barriers

Installation Overview

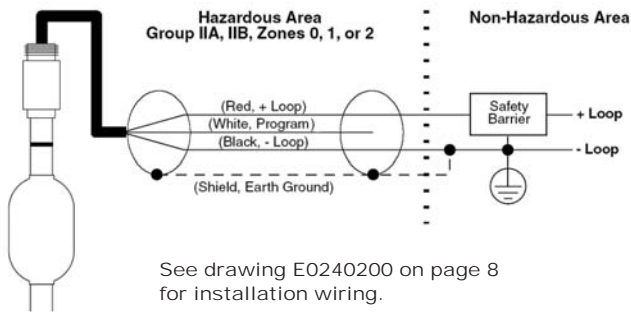

CAUTION

If the sensor is located in a hazardous environment, do not make any electrical connections without first disconnecting electrical power at the source. Ensure that wiring connections conform to electrical codes for the specific location and hazard level. Refer to Installation Drawing E0240200 on page 8 for product specific information.

Select either a single or dual channel barrier complying with the requirements called out in Installation Drawing E0240200 on page 8.

Single channel barrier can only be used if the meter (resistive load) is placed in the positive end of the loop and the meter has a differential input.

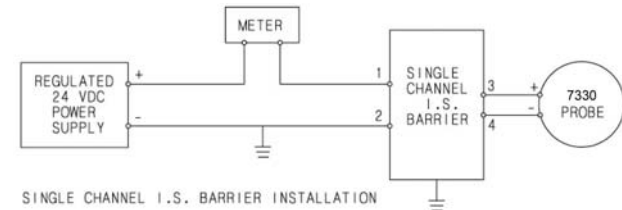

If the meter (resistive load) must have one side connected to ground, then a dual channel barrier must be used.

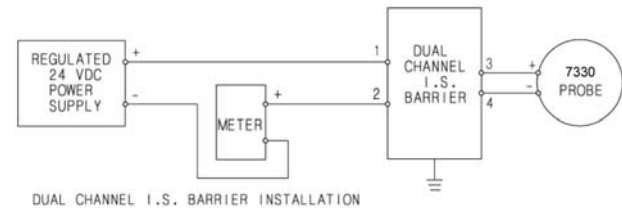

M Style Probe Mini Connector Cordset for Quick Disconnect Applications

SIGNAL NAME	"M" CONN. PIN NUMBER	PIGTAIL CABLE	CORDSET TYPE	
			US	EU
LOOP (-)	1	BLACK	BLACK	BLACK
PRGM INPUT	2	WHITE	WHITE	BLUE
LOOP (+)	3	RED	RED	BROWN
CHASSIS GND	4	DRAIN WIRE	GREEN	WHITE

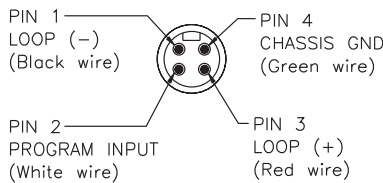

NOTE: Electrically insulate the Program Input wire during normal operation to prevent inadvertent setting of the zero or the span points.

Specifications

Specifications			
Operating Voltage	13.5 to 30 VDC	Intrinsically Safe Barrier	See Installation Drawing E0240200 on page 8
Output		Enclosure	Probe: 316 SS or PVDF
Operating Output	4 to 20mA	Material Rating	IP68
Diagnostic Output	3.9mA and 20.1mA, float outside of span 3.8mA, no signal received (Note: Diagnostic Tolerance +/- 0.02mA)		
Operating Temperature		Probe Length	
Hazardous Locations	-40°C to 70° C	Stainless Steel R	19" to 288"
Non Hazardous Location		Stainless Steel D, S, M	18" to 288" * Consult Factory
Sensing Area	-40°C to 100° C	PVDF Style C	20" to 192"
Electronic Area	-40°C to 70° C	PVDF Style X	25" to 840"
Pressure Rating	316SS Probe: 1000 psi max. PVDF Probe: 150 psi max. Floats: Dependent. Call Factory.	Hazardous Areas Approvals	
Resolution	0.025% of span or 0.014", (Whichever is Greater)	cFMus	
Repeatability	0.014" + 0.05% of span typical, 0.014" + 0.4% of span maximum	-40° ≤ Tamb ≤ 70° C	
Accuracy	0.1% of span or 0.050" (Whichever is Greater)	Class I, II, III, Div. 1	
Null Zone	8"	Groups C, D, E, F, G, T4	
Dead Band	2"	Class I, Div. 2	
		Groups A, B, C, D, T4	
		Class I, Zone 0, AEx ia IIB T4	
		ATEX	
		Ex ia IIB T4	
		FM FM13ATEX0028X	
		(See PVDF installation note)	
		CE 0575 Ex II 1G	

Diagnostics and Symptoms

1. Float magnet is outside of the programmed span
 - a. Beyond 4mA set point is indicated as 3.9mA.
 - b. Beyond 20mA set point is indicated as 20.1mA.
2. Loss of signal, sensor failure, or float outside active range (top or bottom) is indicated as 3.8mA.

Symptom	Troubleshooting Tip
No signal received at controller	<ul style="list-style-type: none"> • Check that power is applied to controller • Check wiring connection to probe
Output is 3.8mA	<ul style="list-style-type: none"> • Be sure float retention clip is in place at base of probe and float is installed • Be sure float is in active region and not stuck in Null or Dead Zone • Reset Gain • Check temperature of process. Cannot be greater than 230°F (110°C)
Output appears erratic	<ul style="list-style-type: none"> • Be sure probe is mounted perpendicular with gravity • Check float for free movement along probe • Reset Gain
Output appears to be going down, yet tank is filling	<ul style="list-style-type: none"> • Check configuration of 4mA & 20mA points
Output appears to be going up, yet tank is emptying	<ul style="list-style-type: none"> • Check configuration of 4mA & 20mA points
Output is not scaled properly	<ul style="list-style-type: none"> • Re-set both Zero (4mA) and Span (20mA) points.
Panel Meter error	<ul style="list-style-type: none"> • Check to see if the panel meter being used is "confused" by an output of less than 4mA or more than 20mA. 3.9mA, 3.8mA or 20.1mA are diagnostic outputs and should be used for alarms.

(All diagnostic values with tolerances $\pm 0.02\text{mA}$)

Gain Control

The internal signal gain is set at the factory and should not need to be adjusted in the field. However, if the output signal is unstable (i.e. the output goes to 3.8mA with the float in place), or the probe is being applied in a high temperature application, the internal signal gain may be re-set as follows:

Manual Setting of Gain

1. Place the float near the end of the probe.
2. Power down the probe.
3. Short the White "program" wire to the Black "Loop –" wire and apply power with the wires shorted.
4. Output goes from 12mA to 20mA if successful.
5. Output will go to 3.8mA if gain setting failed.
6. Power down the probe and remove the short between the White "program" wire and the Black "Loop –" wire.

7. Apply power, the probe will return in normal 4 to 20mA mode with the new gain set.
8. If the signal does not return to normal, and the problem was not solved, contact your distributor.

Optional Push Button Setting of Gain

1. Place the float near the end of probe.
2. Power down the probe.
3. Hold down the Zero button and apply power.
4. Output goes from 12mA to 20mA if successful.
5. Output will go to 3.8mA if AGC failed.
6. Power down the probe and release the Zero button.
7. Apply power, the probe will return in normal 4 to 20mA mode with the new gain set.
8. If the signal does not return to normal, and the problem was not solved, contact your distributor.

Additional Information

See addendum information for sanitary and flex probe installation instructions.

7330 Sanitary 3A Probes Data Sheet Z157

7330 316 Stainless Steel Probes Data Sheet Z154

7330 PVDF Flex Probes Data Sheet Z177

Flex Probe Installation & Handling Procedure Z190

Equipment Return

In order to provide prompt and reliable service, any equipment being returned for repair or credit, must be pre-approved by the factory.

You must have a Returned Material Authorization Number! To obtain a Returned Material Authorization (RMA#), contact your distributor.

Please provide the following information:

- Model Number of returned equipment
- Serial Number
- Original Purchase Order Number
- Detailed description of the failure
- Contact Name and Phone Number

In many applications, the probes are exposed to hazardous materials. It is your responsibility to fully disclose all chemicals and decontaminate the entire product.

- OSHA mandates that our employees be informed and protected from hazardous chemicals.
- A **Material Safety Data Sheet (MSDS)** listing any hazardous material to which the probe has been exposed **MUST** accompany any return.

REV.	DESCRIPTION	DATE	BY
A	REVISED DWG FOR CSA & NEMKO	8/3/04	KTP

NOTES: UNLESS OTHERWISE SPECIFIED

- MINIMUM VOLTAGE TO OPERATE THE 7330 PROBE IS 13.5V.
- THE SELECTED BARRIER SHALL BE APPROVED WITH INTRINSICALLY SAFE CIRCUITS FOR THE HAZARDOUS LOCATION GROUP AND ZONE AS APPROPRIATE FOR THE APPLICATION AND INSTALLED IN ACCORDANCE WITH MANUFACTURER'S INSTALLATION INSTRUCTIONS.
- ELECTRONIC EQUIPMENT CONNECTED TO THE ASSOCIATED APPARATUS MUST NOT USE OR GENERATE MORE THAN 250Vrms WITH RESPECT TO EARTH GROUND.
- INSTALLATIONS SHALL COMPLY WITH THE LATEST EDITION OF THE NATIONAL ELECTRICAL CODE (ANSI/NFPA 70) AND THE CANADIAN ELECTRICAL CODE (CEC).
- ALL CABLES MUST BE 24 GAUGE OR HEAVIER.
- SAFETY BARRIER (2) IS ONLY REQUIRED IF THE PROGRAMMING PIN IS BROUGHT INTO THE NON HAZARDOUS AREA.
- IF SAFETY BARRIER (2) IS NOT REQUIRED BECAUSE PROGRAMMING PIN IS NOT IN THE NON HAZARDOUS AREA, SET SAFETY BARRIER (2) ENTITY PARAMETERS TO ZERO (0) FOR SAFETY BARRIER (1) CALCULATIONS.
- ONLY ONE CONNECTION SCHEME (1 OR 2) MUST BE USED AS APPLICABLE.
- APPLY CONNECTION TO ONLY ONE PROBE USING APPLICABLE JUNCTION BOX TYPE.
- INSTALLATIONS SHALL BE IN ACCORDANCE WITH ANSI/ISA RP12.6, INSTALLATION OF INTRINSICALLY SAFE SYSTEMS FOR HAZARDOUS (CLASSIFIED) LOCATIONS.

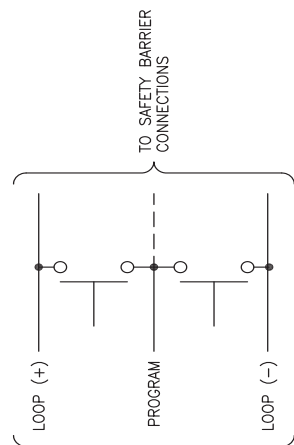

WIRING SCHEMATIC FOR JUNCTION BOX

THIRD ANGLE PROJECTION	DR. KTP	TITLE
	DATE 4/8/04	INSTALLATION DRAWING
	APP.	7330 TANK PROBE
UNLESS OTHERWISE SPECIFIED	DATE	W/ JUNCTION BOX
TOLERANCE ALLOWANCE	SCALE	DRAWING NO.
UNLESS OTHERWISE SPECIFIED:	NONE	E0240200
+/- 0.010 ON 2 PLACE DECIMALS		REV. SIZE
+/- 0.005 ON 3 PLACE DECIMALS		A
+/- 0.0005 ON 4 PLACE DECIMALS		B



GROUP IIA, IIB, ZONES 0,1
 GROUP IIC, ZONE 2
 CLASS I, DIV 1, GROUPS C & D
 CLASS II & III, GROUPS E, F & G
 CLASS I, DIV 2, GROUPS A, B, C & D

APPROVED DOCUMENT
 CHANGES TO THIS DOCUMENT
 REQUIRE AGENCY APPROVAL

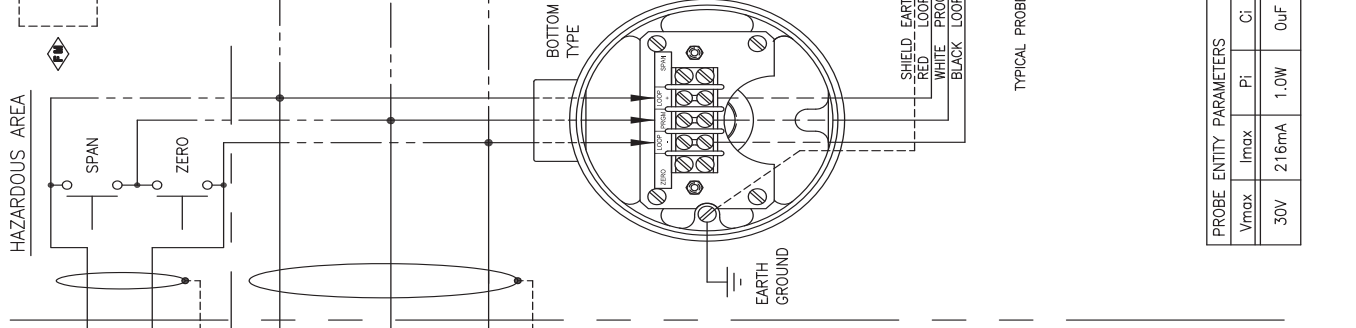

SEE NOTE 8

CONNECTION SCHEME 2:
 IF PROGRAMMING PIN IS IN NON HAZARDOUS LOCATION.

TERMINATE BARRIER EARTH GROUND TO THE GROUND BUS OF THE POWER DISTRIBUTION PANEL. RESISTANCE TO GROUND MUST NOT BE GREATER THAN 1 OHM.

SEE NOTE 7

LOOP + ZENER BARRIER PARAMETERS (1)	
Voc(1)	$\leq V_{max}$
Isc(1)	$\leq I_{max} - I_{sc(2)}$
Ca(1)	$\geq C_i + C_{wire(1)} + C_{wire(2)}$
La(1)	$\geq [L_i + L_{wire(1)} + L_{wire(2)}] - La(2)$

PROGRAM ZENER BARRIER PARAMETERS (2)	
Voc(2)	$\leq V_{max}$
Isc(2)	$\leq I_{max} - I_{sc(1)}$
Ca(2)	$\geq C_i + C_{wire(2)} + C_{wire(1)}$
La(2)	$\geq [L_i + L_{wire(2)} + L_{wire(1)}] - La(1)$

It = Isc(1) + Isc(2)
 It <= I_{max}
 Vt = MAXIMUM VOLTAGE OF Voc(1) AND Voc(2)
 Vt <= V_{max}

La(total) = La(1) + La(2)
 La(total) >= Li + Lwire(1) + Lwire(2)

IF WIRE PARAMETERS ARE UNKNOWN THEN THE FOLLOWING SHALL BE USED:
 $C_{wire} = 60pF/ft. (197pF/m.)$
 $L_{wire} = .2uH/ft. (0.657uH/m.)$

FOR EXAMPLE: 1000 ft x 60 pF/ft. = 0.06uF
 100 m x 197 pF/m. = 0.0197uF

PROBE ENTITY PARAMETERS				
V _{max}	I _{max}	Pi	Ci	Li
30V	216mA	1.0W	0uF	0mH

EC Declaration of Conformity

Manufacturer: AMETEK Automation & Process Technologies
6380 Brockway Road, Peck, MI 48466 USA

Identification of Equipment:
Series 7330 "Pro Stik II" Liquid Level Sensor

Description of Device:

These devices are permanently mounted Intrinsically Safe Magnetostrictive based liquid level sensing transducers. The level information is conveyed by an analog 4-20mA output signal. The sensor is loop powered with a maximum power supply voltage of +30Vdc. The devices can be specified with either PVDF or steel housing materials.

EC type certificate: FM Approvals Ltd. 1725 FM13ATEX0028X
FM Approvals Ltd. 1 Windsor Dials, Windsor, Berkshire, UK. SL4 1RS

Conformity Specifications:  II 1 G Ex ia IIB T4 Ta : -40°C to +70°C

Council Directives:

Directive 94/9/EC, ATEX

Directive 89/336/EEC, EMC

Harmonized Standards:

EN60079-0:2012	Electrical apparatus for explosive gas atmospheres - Part 0: General requirements
EN60079-11:2012	Electrical apparatus for explosive gas atmospheres - Part 11: Intrinsic safety "i"
EN60079-26:2007	Electrical apparatus for explosive gas atmospheres – Part 26: Construction, test and marking of group II category I G electrical apparatus
EN55011:1998	Limits and methods of measurement of radio characteristics of industrial, scientific and medical (ISM) Radio Frequency equipment, Class B, Group 1
EN61326:2002-02	Electrical Equipment for measurement, control and laboratory use – EMC Requirements
EN61000-4-2:1995	Electrostatic Discharge Immunity
EN61000-4-3:1995	Radiated RF Immunity

Signed: 

Name: Glenn S Loding

Dated: 4/30/2013

Position: Engineering Manager

Company: AMETEK Automation & Process Technologies



Other Products		

Copyright 2013 by AMETEK AUTOMATION & PROCESS TECHNOLOGIES.
All Rights Reserved. Made in the USA.



1080 N. Crooks Road, Clawson, MI 48017-1097
Phone: 248-435-0700 Toll Free: 800-635-0289
Fax: 248-435-8120 www.AMETEKAPT.com

7330.M14R
9/13.Z164